



# **RADIO TEST REPORT**

## **ETSI EN 300 328 V2.1.1 (2016-11)**

**Product :** Sonoff WiFi smart switch  
**Trade Name :**   
**Model Name :** Sonoff RF  
**Serial Model :** Sonoff Basic  
**Report No. :** BCTC-FY180100467-3E

### **Prepared for**

**Shenzhen Sonoff Technologies Co.,Ltd.**

301, 3F, BLDG 52, the Third Industrial Park, Bantian, Longgang Dist  
Shenzhen, GD, 518055 China.

### **Prepared by**

**Shenzhen BCTC Testing Co., Ltd.**

BCTC Building & 1-2F, East of B Building, Pengzhou Industrial, Fuyuan 1st  
Road, Qiaotou Community, Fuyong Street, Bao'an District, Shenzhen, China

Tel: 400-788-9558, 0755-33019988

Web: [Http://www.bctc-lab.com.cn](http://www.bctc-lab.com.cn)



### TEST RESULT CERTIFICATION

**Applicant's name**.....: **Shenzhen Sonoff Technologies Co.,Ltd.**  
**Address** .....: 301, 3F, BLDG 52, the Third Industrial Park, Bantian,  
 Longgang Dist Shenzhen, GD, 518055 China.  
**Manufacture's Name** .....: **Shenzhen Sonoff Technologies Co.,Ltd.**  
**Address** .....: 301, 3F, BLDG 52, the Third Industrial Park, Bantian,  
 Longgang Dist Shenzhen, GD, 518055 China.

#### Product description

**Product name** .....: Sonoff WiFi smart switch  
**Trademark** .....:   
**Model and/or type reference** ..: Sonoff RF  
**Serial Model** .....: Sonoff Basic

**Standards**.....: ETSI EN 300 328 V2.1.1 (2016-11)

This device described above has been tested by BCTC, and the test results show that the equipment under test (EUT) is in compliance with the 2014/53/EU RED Directive Art.3.2 requirements. And it is applicable only to the tested sample identified in the report.

This report shall not be reproduced except in full, without the written approval of BCTC, this document may be altered or revised by BCTC, personal only, and shall be noted in the revision of the document.

**Date of Test**.....: .....  
**Date (s) of performance of tests**.....: Feb. 01 – Feb. 08, 2018  
**Date of Issue** .....: Feb. 08, 2018  
**Test Result** .....: **Pass**

Prepared by(Engineer): Willem Wang

*Willem Wang*

Reviewer(Supervisor): Rita Xiao

*Rita Xiao*

Approved(Manager): Carson Zhang

*Carson Zhang*



*This test report is based on a single evaluation of one sample of above mentioned products. It is not permitted to be duplicated in extracts without written approval of Shenzhen BCTC Testing Co., Ltd.*



<b>Table of Contents</b>	<b>Page</b>
<b>1 . SUMMARY OF TEST RESULTS .....</b>	<b>5</b>
<b>2 GENERAL INFORMATION .....</b>	<b>7</b>
<b>3 . RF OUTPUT POWER .....</b>	<b>14</b>
3.1 LIMIT.....	14
3.2 TEST SETUP.....	14
3.3 TEST PROCEDURE.....	14
3.4 TEST RESULT .....	14
<b>4 . POWER SPECTRAL DENSITY .....</b>	<b>19</b>
4.1 LIMIT.....	19
4.2 TEST SETUP.....	19
4.3 TEST PROCEDURE.....	19
4.4 TEST RESULT .....	20
<b>5 . ADAPTIVITY .....</b>	<b>26</b>
5.1 LIMIT.....	26
5.2 TEST SETUP.....	26
5.3 TEST PROCEDURE.....	26
5.4 TEST RESULT .....	28
<b>6 . OCCUPIED CHANNEL BANDWIDTH.....</b>	<b>37</b>
6.1 LIMIT.....	37
6.2 TEST SETUP.....	37
6.3 TEST PROCEDURE.....	37
6.4 TEST RESULT .....	38
<b>7 . TRANSMITTER UNWANTED EMISSIONS IN THE OUT-OF-BAND DOMAIN .....</b>	<b>42</b>
7.1 LIMIT.....	42
7.2 TEST SETUP.....	42
7.3 TEST PROCEDURE.....	43
7.4 TEST RESULT .....	43
<b>8 . RECEIVER BLOCKING .....</b>	<b>57</b>
8.1 LIMIT.....	57
8.2 TEST SETUP.....	57
8.3 TEST PROCEDURE.....	57
8.4 TEST RESULT .....	57
<b>9 . SPURIOUS EMISSIONS – TRANSMITTER (30- 1000MHZ) .....</b>	<b>58</b>
9.1 APPLIED PROCEDURES / LIMIT.....	58
9.1.1 <i>Measuring Instruments and Setting</i> .....	58
9.1.2 <i>Test Procedures</i> .....	58
9.1.3 <i>Test Setup Layout</i> .....	59
9.1.4 <i>EUT Operation during Test</i> .....	59
9.1.5 <i>Results of Standby Mode Spurious Emissions</i> .....	59
9.1.6 <i>TEST RESULTS (30MHz ~ 1000MHz)</i> .....	59



<b>Table of Contents</b>	<b>Page</b>
<b>10 . SPURIOUS EMISSIONS – TRANSMITTER (ABOVE 1000MHZ) .....</b>	<b>62</b>
10.1 APPLIED PROCEDURES / LIMIT.....	62
10.1.1 <i>Measuring Instruments and Setting</i> .....	62
10.1.2 <i>Test Procedures</i> .....	62
10.1.3 <i>Test Setup Layout</i> .....	63
10.1.4 <i>EUT Operation during Test</i> .....	63
10.1.5 <i>Results of Standby Mode Spurious Emissions</i> .....	63
10.1.6 <i>TEST RESULTS</i> .....	64
<b>11 . SPURIOUS EMISSIONS – RECEIVER (30-1000MHZ).....</b>	<b>67</b>
11.1 APPLIED PROCEDURES / LIMIT.....	67
11.1.1 <i>Measuring Instruments and Setting</i> .....	67
11.1.2 <i>Test Procedures</i> .....	67
11.1.3 <i>Test Setup Layout</i> .....	67
11.1.4 <i>EUT Operation during Test</i> .....	67
11.1.5 <i>TEST RESULTS (30MHz-1000MHz)</i> .....	68
<b>12 . SPURIOUS EMISSIONS – RECEIVER (ABOVE 1000MHZ).....</b>	<b>69</b>
12.1 APPLIED PROCEDURES / LIMIT.....	69
12.1.1 <i>Measuring Instruments and Setting</i> .....	69
12.1.2 <i>Test Procedures</i> .....	69
12.1.3 <i>Test Setup Layout</i> .....	69
12.1.4 <i>EUT Operation during Test</i> .....	69
12.1.5 <i>TEST RESULTS (Above 1000MHz)</i> .....	70
<b>13 . TEST PHOTOGRAPH .....</b>	<b>71</b>
<b>14. PHOTOS OF THE EUT.....</b>	<b>72</b>



## 1. Summary Of Test Results

Test procedures according to the technical standards:

The following essential requirements and test specifications are relevant to the presumption of conformity under Article 3.2 of the R&TTE Directive			
No	Test Parameter	Clause No	Results
Transmitter Parameters			
1	RF output power	4.3.2.1	PASS
2	Power Spectral Density	4.3.2.2	PASS
3	Duty Cycle, Tx-sequence, Tx-gap	4.3.2.3	N/A
4	Dwell time, Minimum Frequency Occupation & Hopping Sequence	4.3.1.3	N/A
5	Hopping Frequency Separation	4.3.1.4	N/A
6	Medium Utilisation (MU) factor	4.3.2.4	N/A
7	Adaptivity (adaptive equipment using modulations other than FHSS)	4.3.2.5	PASS
8	Occupied Channel Bandwidth	4.3.2.6	PASS
9	Transmitter unwanted emissions in the out-of-band domain	4.3.2.7	PASS
10	Transmitter unwanted emissions in the spurious domain	4.3.2.8	PASS
Receiver Parameters			
11	Receiver spurious emissions	4.3.2.9	PASS
12	Receiver Blocking	4.3.2.10	PASS
Note: N/A is an abbreviation for Not Applicable and means this test item is not applicable for this device according to the technology characteristic of device.			



## 1.1 Test Facility

The test facility is recognized, certified, or accredited by the following organizations:

- **FCC —Registration No.: 370994**

Keyway Testing Technology Co., Ltd., EMC Laboratory has been registered and fully described in a report filed with the (FCC) Federal Communications Commission. The acceptance letter from the FCC is maintained in files. Registration 370994, February 21, 2012

- **Industry Canada (IC)**

The 3m Semi-anechoic chamber of Keyway Testing Technology Co., Ltd. has been Registered by Certification and Engineering Bureau of Industry Canada for radio equipment testing with Registration No.: 9868A -1.

## 1.2 Measurement Uncertainty

Measurement Uncertainty for a Level of Confidence of 95 %,  $U=2xUc(y)$

RF frequency	$1 \times 10^{-7}$
RF power, conducted	$\pm 1.0$ dB
Conducted emission of receivers	$\pm 1$ dB
Radiated emission of transmitter	$\pm 6$ dB
Radiated emission of receiver	$\pm 6$ dB
Temperature	$\pm 1$ degree
Humidity	$\pm 5$ %



## 2 General Information

### 2.1 General Description Of EUT

Product Name:	Sonoff WiFi smart switch
Model No.:	Sonoff RF
Serial Model:	Sonoff Basic
Operation Frequency:	WIFI:2412MHz~2472MHz (802.11b/802.11g/802.11n(H20))
Channel numbers:	WIFI: 13 for 802.11b/802.11g/802.11n(H20) ,
Channel separation:	WIFI : 5MHz
Modulation technology:	WIFI: Direct Sequence Spread Spectrum (DSSS) for 802.11b Orthogonal Frequency Division Multiplexing(OFDM) for 802.11g/n
Data rate:	802.11b: 1Mbps, 2Mbps, 5.5Mbps, 11Mbps 802.11g: 6Mbps, 9Mbps, 12Mbps, 18Mbps, 24Mbps, 36Mbps, 48Mbps,54Mbps 802.11n: Up to 75Mbps
Antenna Type:	Internal antenna
Antenna gain:	1dBi
Power supply:	AC 90V~250V 50Hz-60Hz 2200W 10A

Note:

1. For a more detailed features description, please refer to the manufacturer's specifications or the User's Manual.

2.

Channel List for 802.11b/g/n(20MHz)							
Channel	Frequency (MHz)	Channel	Frequency (MHz)	Channel	Frequency (MHz)	Channel	Frequency (MHz)
01	2412	05	2432	09	2452	13	2472
02	2417	06	2437	10	2457		
03	2422	07	2442	11	2462		
04	2427	08	2447	12	2467		

### 3 Annex E

**a) The type of modulation used by the equipment:**

- FHSS  
 other forms of modulation

**b) In case of FHSS modulation:**

- In case of non-Adaptive Frequency Hopping equipment:  
The number of Hopping Frequencies:
- In case of Adaptive Frequency Hopping Equipment:  
The maximum number of Hopping Frequencies:  
The minimum number of Hopping Frequencies:  
The Dwell Time:  
The Minimum Channel Occupation Time:

**c) Adaptive / non-adaptive equipment:**

- non-adaptive Equipment  
 adaptive Equipment without the possibility to switch to a non-adaptive mode



- adaptive Equipment which can also operate in a non-adaptive mode

**d) In case of adaptive equipment:**

The Channel Occupancy Time implemented by the equipment: ms

- The equipment has implemented an LBT based DAA mechanism
  - In case of equipment using modulation different from FHSS:
    - The equipment is Frame Based equipment
    - The equipment is Load Based equipment
    - The equipment can switch dynamically between Frame Based and Load Based equipment

The CCA time implemented by the equipment: .....  $\mu$ s

The value q as referred to in clause 4.3.2.5.2.2.2 .....

- The equipment has implemented an non-LBT based DAA mechanism
- The equipment can operate in more than one adaptive mode

**e) In case of non-adaptive Equipment:**

The maximum RF Output Power (e.i.r.p.): 14.80 dBm

The maximum (corresponding) Duty Cycle: ..... %

Equipment with dynamic behaviour, that behaviour is described here. (e.g. the different combinations of duty cycle and corresponding power levels to be declared):

**f) The worst case operational mode for each of the following tests:**

- RF Output Power  
802.11b
- Power Spectral Density  
802.11b
- Duty cycle, Tx-Sequence, Tx-gap  
802.11b
- Dwell time, Minimum Frequency Occupation & Hopping Sequence (only for FHSS equipment)
- Hopping Frequency Separation (only for FHSS equipment)
- Medium Utilisation
- .....
- Adaptivity & Receiver Blocking
- .....
- Occupied Channel Bandwidth  
802.11n(HT20)
- Transmitter unwanted emissions in the OOB domain  
802.11b
- Transmitter unwanted emissions in the spurious domain  
802.11b
- Receiver spurious emissions

**g) The different transmit operating modes (tick all that apply):**

- Operating mode 1: Single Antenna Equipment
  - Equipment with only 1 antenna
    - Equipment with 2 diversity antennas but only 1 antenna active at any moment in time
    - Smart Antenna Systems with 2 or more antennas, but operating in a (legacy) mode where only 1 antenna is used. (e.g. IEEE 802.11™ [i.3] legacy mode in smart antenna systems)
  - Operating mode 2: Smart Antenna Systems - Multiple Antennas without beam forming
    - Single spatial stream / Standard throughput / (e.g. IEEE 802.11™ [i.3] legacy mode)
    - High Throughput (> 1 spatial stream) using Occupied Channel Bandwidth 1
    - High Throughput (> 1 spatial stream) using Occupied Channel Bandwidth 2
- NOTE: Add more lines if more channel bandwidths are supported.
- Operating mode 3: Smart Antenna Systems - Multiple Antennas with beam forming
  - Single spatial stream / Standard throughput (e.g. IEEE 802.11™ [i.3] legacy mode)
  - High Throughput (> 1 spatial stream) using Occupied Channel Bandwidth 1



High Throughput (> 1 spatial stream) using Occupied Channel Bandwidth 2

NOTE: Add more lines if more channel bandwidths are supported.

**h) In case of Smart Antenna Systems:**

- The number of Receive chains: .....
- The number of Transmit chains: .....
- symmetrical power distribution
- asymmetrical power distribution

In case of beam forming, the maximum beam forming gain: .....

NOTE: Beam forming gain does not include the basic gain of a single antenna.

**i) Operating Frequency Range(s) of the equipment:**

- Operating Frequency Range 1: 2412 MHz to 2472 MHz
- Operating Frequency Range 2:

NOTE: Add more lines if more Frequency Ranges are supported.

**j) Occupied Channel Bandwidth(s):**

Occupied Channel Bandwidth : 11.719MHz

Occupied Channel Bandwidth 2: 17.987MHz

NOTE: Add more lines if more channel bandwidths are supported.

**k) Type of Equipment (stand-alone, combined, plug-in radio device, etc.):**

- Stand-alone
- Combined Equipment (Equipment where the radio part is fully integrated within another type of equipment)
- Plug-in radio device (Equipment intended for a variety of host systems)
- Other .....

**l) The extreme operating conditions that apply to the equipment:**

Operating temperature range:-20° C to 55° C

Operating voltage range: 207V to 253V  AC  DC

Details provided are for the:  stand-alone equipment

combined (or host) equipment

test jig

**m) The intended combination(s) of the radio equipment power settings and one or more antenna assemblies and their corresponding e.i.r.p levels:**

- Antenna Type

Integral Antenna

Antenna Gain: 1 dBi

If applicable, additional beamforming gain (excluding basic antenna gain): ..... dB

Temporary RF connector provided

No temporary RF connector provided

Dedicated Antennas (equipment with antenna connector)

Single power level with corresponding antenna(s)

Multiple power settings and corresponding antenna(s)

Number of different Power Levels: .....

Power Level 1: ..... dBm

Power Level 2: ..... dBm

Power Level 3: ..... dBm

NOTE 1: Add more lines in case the equipment has more power levels.

NOTE 2: These power levels are conducted power levels (at antenna connector).

**n) The nominal voltages of the stand-alone radio equipment or the nominal voltages of the combined (host) equipment or test jig in case of plug-in devices:**

Details provided are for the:  stand-alone equipment

combined (or host) equipment

test jig

Supply Voltage  AC mains State AC voltage ...230V

DC State DC voltage : V



In case of DC, indicate the type of power source

- Internal Power Supply
- External Power Supply or AC/DC adapter
- Battery: V
- Other: .....

**o) Describe the test modes available which can facilitate testing:**

The EUT can be into the Engineer mode for testing.

**p) The equipment type (e.g. Bluetooth®, IEEE 802.11™ [i.3], proprietary, etc.):**

WIFI



## 2.2 Description Of Test Conditions

(1) EUT was tested in normal configuration (Please See following Block diagram)

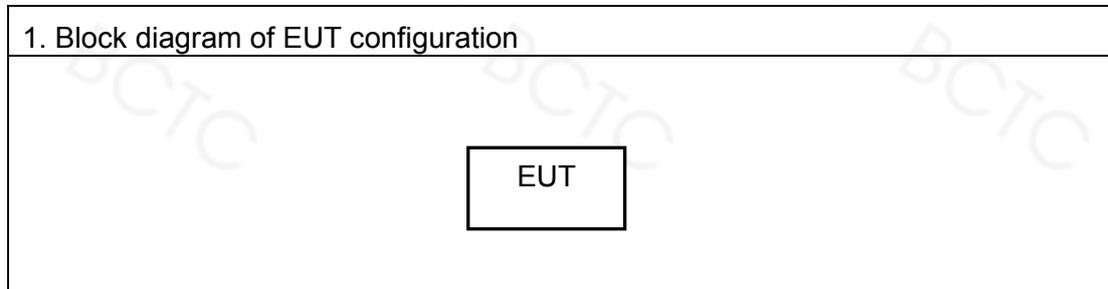

## 2.3 Test Conditions and Channel

	Normal Test Conditions	Extreme Test Conditions
Temperature	15°C - 35°C	-20°C ~ 55°C Note: (1)
Relative Humidity	20% - 75%	N/A
Supply Voltage	AC 230V/50HZ	AC 207V – AC 253V Note: (2)

WLAN		
Test Channel	EUT Channel(20MHz)	Test Frequency (MHz)
lowest	CH01	2412
middle	CH07	2442
highest	CH13	2472

### Note:

(1) For tests at extreme temperatures, measurements shall be made in accordance with the procedures specified in clause 5.3.4.3, at the upper and lower temperatures of the range as follow: temperature: -20°C to +55°C;

Where the manufacture's stated operating range does not include the range of -20°C to +55°C, the equipment shall be tested over the following temperature ranges:

- a) 0°C to +35°C for equipment intended for indoor use only, or intended for use in areas where the temperature is controlled within this range;
  - b) over the extremes of the operating temperature range(s) of the stated combination(s) or host equipment(s) in case of plug-in radio devices.
- (2) For the Leclanché or lithium type battery: 0.85 times the nominal voltage of the battery; for the mercury or nickel-cadmium type of battery: 0.9 times the nominal voltage of the battery. In both cases, the upper extreme test voltage shall be 1.15 times the nominal voltage of the battery.
- (3) The measurements are performed at the highest, middle, lowest available channels.
- (4) The measurements are performed at worst mode for 1Mbps and 3Mbps.



## 2.4 Description Of Support Units

The EUT has been tested as an independent unit together with other necessary accessories or support units. The following support units or accessories were used to form a representative test configuration during the tests.

Item	Equipment	Mfr/Brand	Model/Type No.	Series No.	Note
E-1	Sonoff WiFi smart switch		Sonoff RF	N/A	EUT

Item	Shielded Type	Ferrite Core	Length	Note

Note:

- (1) The support equipment was authorized by Declaration of Confirmation.
- (2) For detachable type I/O cable should be specified the length in m in 『Length』 column.



2.5 Equipments List For All Test Items

Item	Kind of Equipment	Manufacturer	Type No.	Serial No.	Cal.Date (mm-dd-yy)	Cal.Due date (mm-dd-yy)
1	Spectrum Analyzer	R&S	FSP_40	100129	Aug. 25, 2017	Aug. 24, 2018
2	Microwave Pre_amplifier	Agilent	8449B	3008A01714	Aug. 25, 2017	Aug. 24, 2018
3	Microflex Cable	United Microwave	57793	1m	Aug. 25, 2017	Aug. 24, 2018
4	Microflex Cable	United Microwave	A30A30-5006	10M	Aug. 25, 2017	Aug. 24, 2018
5	Horn Antenna	EMCO	3115	9605-4803	Aug. 25, 2017	Aug. 24, 2018
6	Horn Ant	Schwarzbeck	BBHA 9170	9170-181	Aug. 25, 2017	Aug. 24, 2018
7	Log-Bicon Antenna	MESS-ELEKTRON IK	VULB 9160	3058	Aug. 25, 2017	Aug. 24, 2018
8	Test Cable	N/A	10M_OS02	N/A	Aug. 25, 2017	Aug. 24, 2018
9	Test Cable	N/A	OS02-1/-2/-3	N/A	Aug. 25, 2017	Aug. 24, 2018
10	Pre-Amplifier	Anritsu	MH648A	M09961	Aug. 25, 2017	Aug. 24, 2018
11	Temperature & Humidity Chamber	GIANT FORCE	GTH-056P	GF-94454-1	Aug. 25, 2017	Aug. 24, 2018
12	Signal Generator	R&S	SMT 06	832080/007	Aug. 25, 2017	Aug. 24, 2018
13	Power Metter	ANRITSU	ML2487A	6K00001568	Aug. 25, 2017	Aug. 24, 2018
14	Power Sensor (AV)	ANRITSU	ML2491A	030989	Aug. 25, 2017	Aug. 24, 2018
15	vector Signal Generator	Agilent	E4438C	MY49070163	Aug. 25, 2017	Aug. 24, 2018
16	splitter	Mini-Circuits	ZAP-50W	NN256400424	Aug. 25, 2017	Aug. 24, 2018
17	Directional Coupler	Agilent	87300C	MY44300299	Aug. 25, 2017	Aug. 24, 2018
18	vector Signal Generator	Agilent	E4438C	US44271917	Aug. 25, 2017	Aug. 24, 2018
19	X-series USB Peak and Average Power Sensor	Agilent	U2021XA	MY54080020	Aug. 25, 2017	Aug. 24, 2018
20	X-series USB Peak and Average Power Sensor	Agilent	U2021XA	MY54110001	Aug. 25, 2017	Aug. 24, 2018
21	X-series USB Peak and Average Power Sensor	Agilent	U2021XA	MY53480008	Aug. 25, 2017	Aug. 24, 2018
22	X-series USB Peak and Average Power Sensor	Agilent	U2021XA	MY54080019	Aug. 25, 2017	Aug. 24, 2018
23	4 Ch.Simultaneous Sampling 14 Bits 2 MS/s	Agilent	U2531A	TW54063507	Aug. 25, 2017	Aug. 24, 2018
24	4 Ch.Simultaneous Sampling 14 Bits 2 MS/s	Agilent	U2531A	TW54063513	Aug. 25, 2017	Aug. 24, 2018
25	splitter	Mini	PS3-7	4463	Aug. 25, 2017	Aug. 24, 2018
26	Signal Analyzer	Agilent	N9010A	MY48030494	Aug. 25, 2017	Aug. 24, 2018



### 3. RF output power

#### 3.1 Limit

For adaptive equipment using wide band modulations other than FHSS, the maximum RF output power shall be 20 dBm.

The maximum RF output power for non-adaptive equipment shall be declared by the supplier and shall not exceed 20 dBm. See clause 5.3.1 m). For non-adaptive equipment using wide band modulations other than FHSS, the maximum RF output power shall be equal to or less than the value declared by the supplier.

This limit shall apply for any combination of power level and intended antenna assembly.

Limit
20dBm

#### 3.2 Test Setup

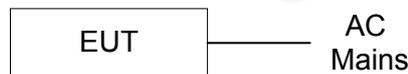

#### 3.3 Test Procedure

Refer to ETSI EN 300 328 V2.1.1 (2016-11) Clause 5.3.2.2

#### 3.4 Test Result



EUT :	Sonoff WiFi smart switch	Model Name :	Sonoff RF
Temperature :	25°C	Relative Humidity :	60 %
Pressure :	1012 hPa	Test Voltage :	See below
Test Mode :	TX 11B Mode CH1 / CH7 / CH13		

TEST CONDITIONS				EIRP Power ( dBm )		
				CH1	CH7	CH13
T nom (°C)	25.00	V nom (V)	230	13.72	14.04	14.80
T min (°C)	-10.00	V max (V)	253	13.52	13.29	13.07
		V min (V)	207	13.62	13.77	13.26
T max (°C)	55.00	V max (V)	253	13.68	13.92	13.52
		V min (V)	207	13.48	13.84	13.62
Max Peak Power				14.80		
Limits				20dBm (-10dBW)		
<b>Result</b>				<b>Complies</b>		

EUT :	Sonoff WiFi smart switch	Model Name :	Sonoff RF
Temperature :	25°C	Relative Humidity :	60 %
Pressure :	1012 hPa	Test Voltage :	See below
Test Mode :	TX 11G Mode CH1 / CH7 / CH13		

TEST CONDITIONS				EIRP Power ( dBm )		
				CH1	CH7	CH13
T nom (°C)	25.00	V nom (V)	230	13.7	14.39	14.24
T min (°C)	-10.00	V max (V)	253	13.52	14.05	13.25
		V min (V)	207	13.33	14.25	14.09
T max (°C)	55.00	V max (V)	253	13.58	13.62	13.26
		V min (V)	207	13.43	13.62	13.74
Max Peak Power				14.39		
Limits				20dBm (-10dBW)		
<b>Result</b>				<b>Complies</b>		



EUT :	Sonoff WiFi smart switch	Model Name :	Sonoff RF
Temperature :	25°C	Relative Humidity :	60 %
Pressure :	1012 hPa	Test Voltage :	See below
Test Mode :	TX 11N(20M) Mode CH1 / CH7 / CH13		

TEST CONDITIONS				EIRP Power ( dBm )		
				CH1	CH7	CH13
T nom (°C)	25.00	V nom (V)	230	13.73	14.35	14.31
T min (°C)	-10.00	V max (V)	253	13.71	14.32	14.09
		V min (V)	207	13.33	14.07	14.31
T max (°C)	55.00	V max (V)	253	12.69	13.77	14.01
		V min (V)	207	13.94	13.68	13.55
Max Peak Power				14.35		
Limits				20dBm (-10dBW)		
<b>Result</b>				<b>Complies</b>		

Remark: This Report only show the test plots of the worst case.



Channel	Voltage	Conducted Power (dBm)	EIRP (dBm)
IEEE 802.b CH Low-2412	Normal	12.72	13.72

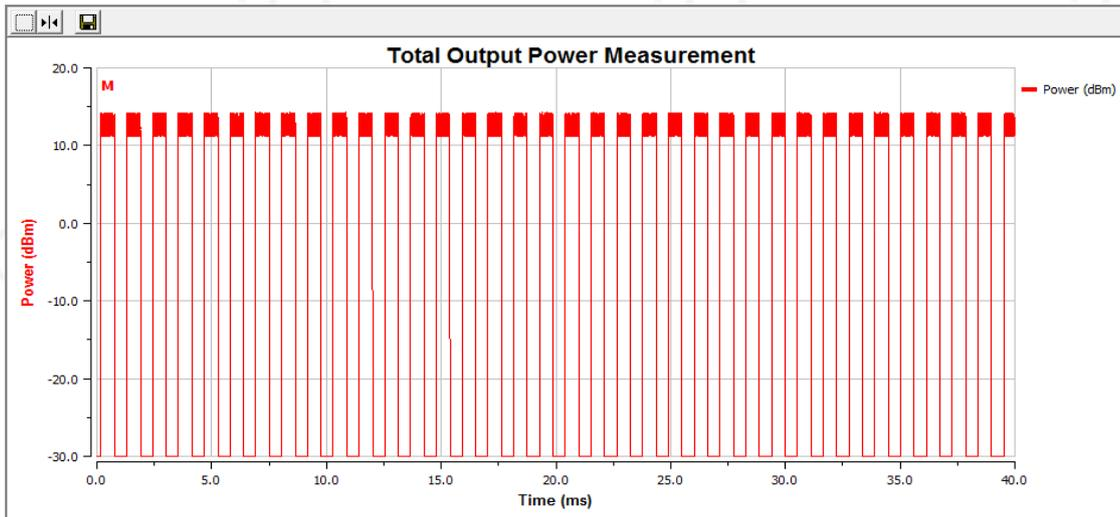

Channel	Voltage	Conducted Power (dBm)	EIRP (dBm)
IEEE 802.b CH Low-2442	Normal	13.04	14.04

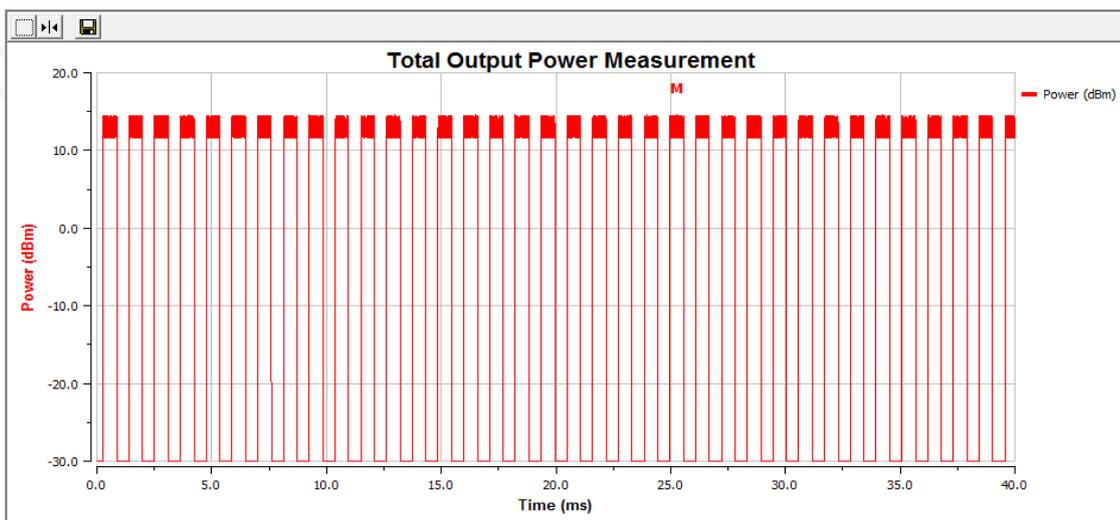



Channel	Voltage	Conducted Power (dBm)	EIRP (dBm)
IEEE 802.b CH Low-2472	Normal	13.80	14.80

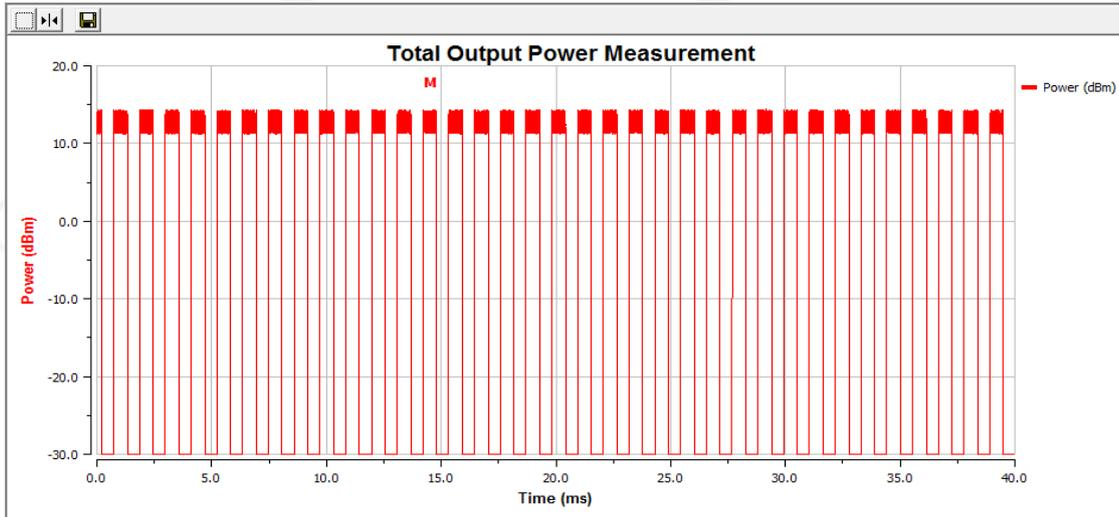



#### 4. Power Spectral Density

##### 4.1 Limit

For equipment using wide band modulations other than FHSS, the maximum Power Spectral Density is limited to 10 dBm per MHz.

Limit
10dBm/MHz

##### 4.2 Test Setup



##### 4.3 Test Procedure

Refer to ETSI EN 300 328 V2.1.1 (2016-11) Clause 5.3.3

Connect the UUT to the spectrum analyzer and use the following settings:

Frequency range	2400MHz-2483.5MHz
RBW/VBW	10KHz/30KHz
Sweep points/time	>8350 / Auto
Detector	RMS
Trace	Max hold



## 4.4 Test Result

EUT :	Sonoff WiFi smart switch	Model Name :	Sonoff RF
Temperature :	25°C	Relative Humidity :	60 %
Pressure :	1012 hPa	Test Voltage :	See below

TX 11B Mode CH1 /CH7/ CH13						
TEST CONDITIONS				EIRP Spectral Power Density (dBm/MHz)		
				CH 1	CH 7	CH 13
T nom (°C)	25.00	V nom (V)	230	5.52	5.81	5.57
Limits				10 mW/MHz		
<b>Result</b>				<b>Complies</b>		

TX 11G Mode CH1 /CH7/ CH13						
TEST CONDITIONS				EIRP Spectral Power Density (dBm/MHz)		
				CH 1	CH 7	CH 13
T nom (°C)	25.00	V nom (V)	230	1.95	2.58	2.49
Limits				10 mW/MHz		
<b>Result</b>				<b>Complies</b>		

TX 11N 20 Mode CH1 /CH7/ CH13						
TEST CONDITIONS				EIRP Spectral Power Density (dBm/MHz)		
				CH 1	CH 7	CH 13
T nom (°C)	25.00	V nom (V)	230	1.69	2.28	2.33
Limits				10 mW/MHz		
<b>Result</b>				<b>Complies</b>		



### Test Detail - Power Spectral Density

Channel	Max Power Spectral Density Level (dBm)
802.11 B CH Low-2412	5.52

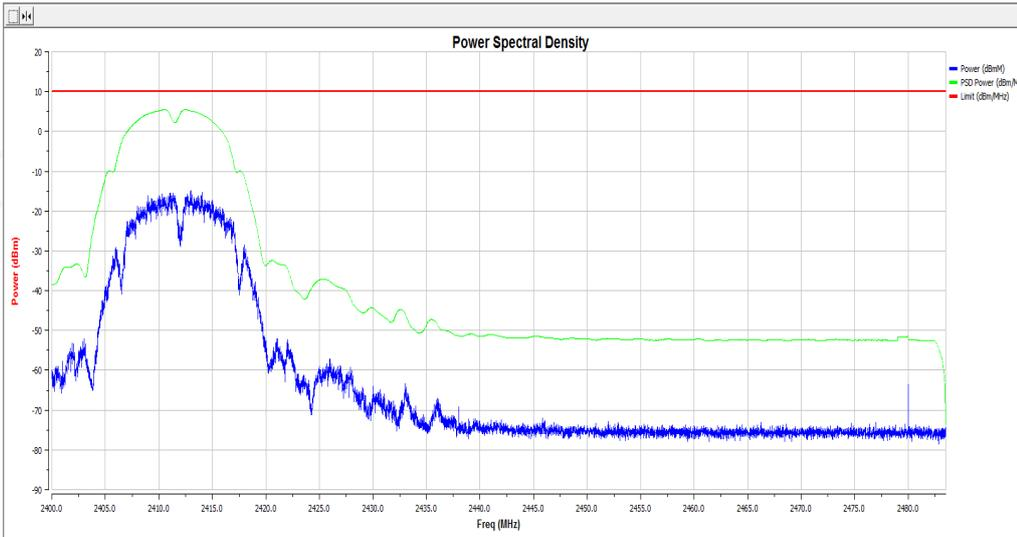

Channel	Max Power Spectral Density Level (dBm)
802.11 B CH Mid-2442	5.81

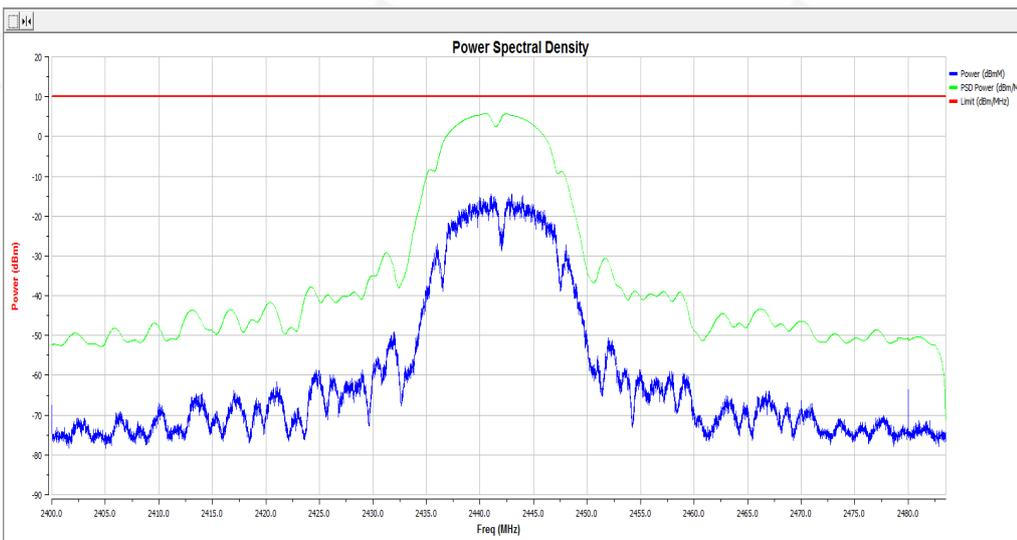



Channel	Max Power Spectral Density Level (dBm)
802.11 B CH High-2472	5.57

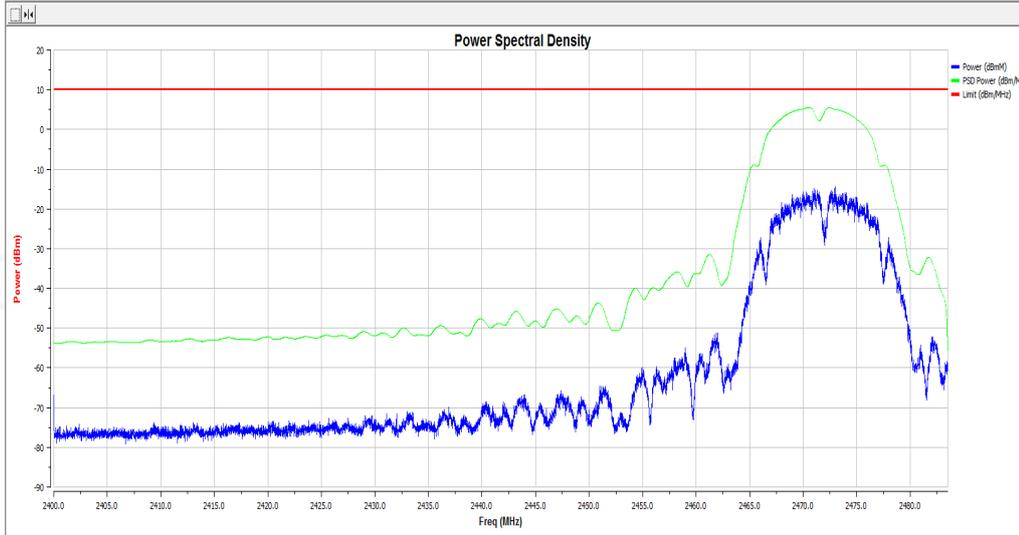

Channel	Max Power Spectral Density Level (dBm)
802.11 G CH Low-2412	1.95

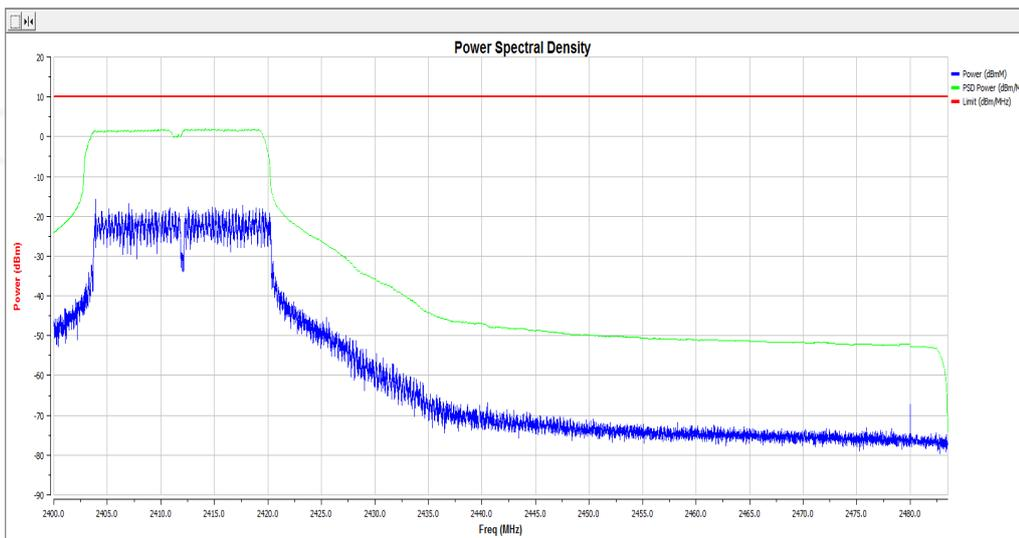



Channel	Max Power Spectral Density Level (dBm)
802.11 G CH Mid-2442	2.58

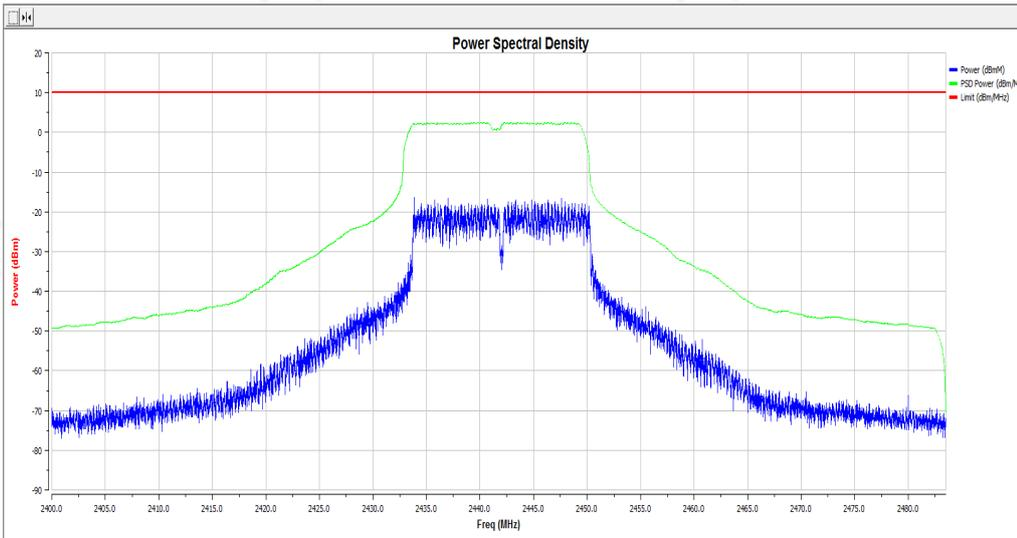

Channel	Max Power Spectral Density Level (dBm)
802.11 G CH High-2472	2.49

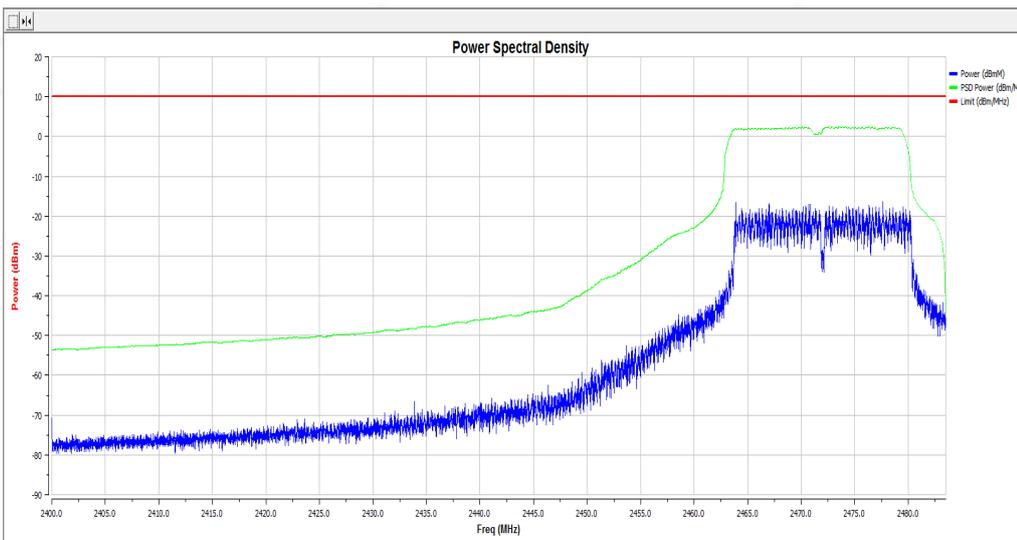



Channel	Max Power Spectral Density Level (dBm)
802.11 N20G CH Low-2412	1.69

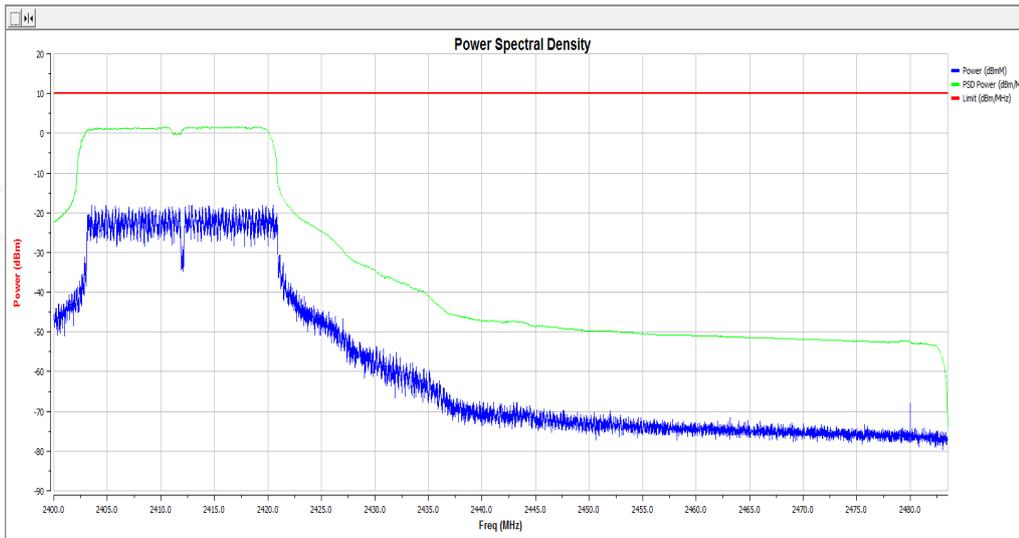

Channel	Max Power Spectral Density Level (dBm)
802.11 N20G CH Mid-2442	2.28

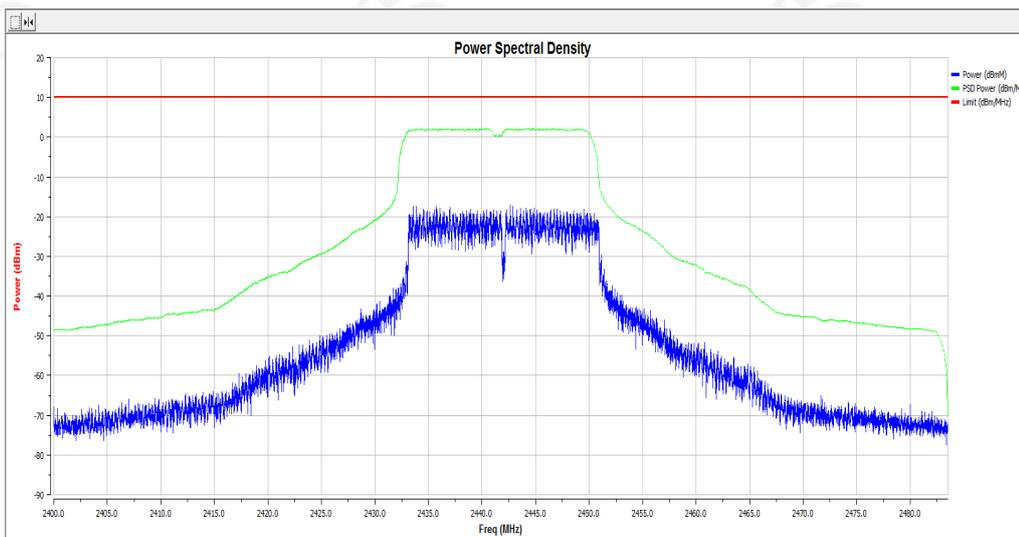



Channel	Max Power Spectral Density Level (dBm)
802.11 N20 CH High-2472	2.33

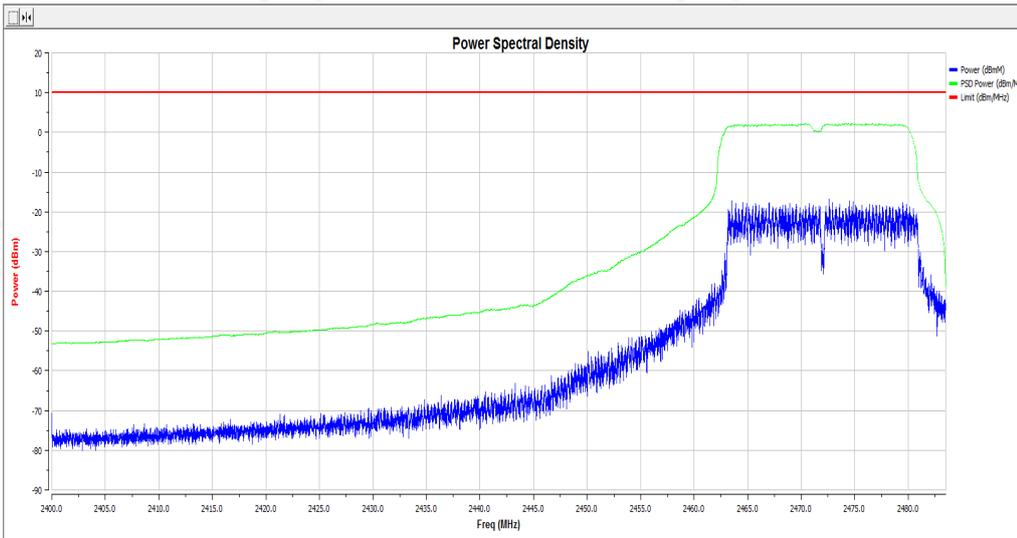

## 5. Adaptivity

### 5.1 Limit

The frequency range of the equipment is determined by the lowest and highest

Non-LBT based Detect and Avoid:

- 1 The frequency shall remain unavailable for a minimum time equal to 1 second after which the channel maybe considered again as an 'available' channel;
- 2 COT  $\leq$  40 ms;
- 3 Idle Period = 5% of COT;
- 4 Detection threshold level =  $-70\text{dBm/MHz} + 20 - \text{Pout E.I.R.P}$  (Pout in dBm);

LBT based Detect and Avoid (Frame Based Equipment):

- 1 Minimum Clear Channel Assessment (CCA) time = 20  $\mu$ s;
- 2 CCA observation time declared by the supplier;
- 3 COT = 1~10 ms;
- 4 Idle Period = 5% of COT;
- 5 Detection threshold level =  $-70\text{dBm/MHz} + 20 - \text{Pout E.I.R.P}$  (Pout in dBm);

LBT based Detect and Avoid (Load Based Equipment):

- 1 Minimum Clear Channel Assessment (CCA) time = 20  $\mu$ s;
- 2 CCA declared by the manufacturer;
- 3 COT  $\leq (13 / 32) * q$  ms; q = [4~32]; 1.625ms~13ms;
- 4 Detection threshold level =  $-73\text{dBm/MHz} + 20 - \text{Pout E.I.R.P}$  (dBm);

Short Control Signalling Transmissions:

Short Control Signalling Transmissions shall have a maximum duty cycle of 10% within an observation period of 50ms.

### 5.2 Test Setup

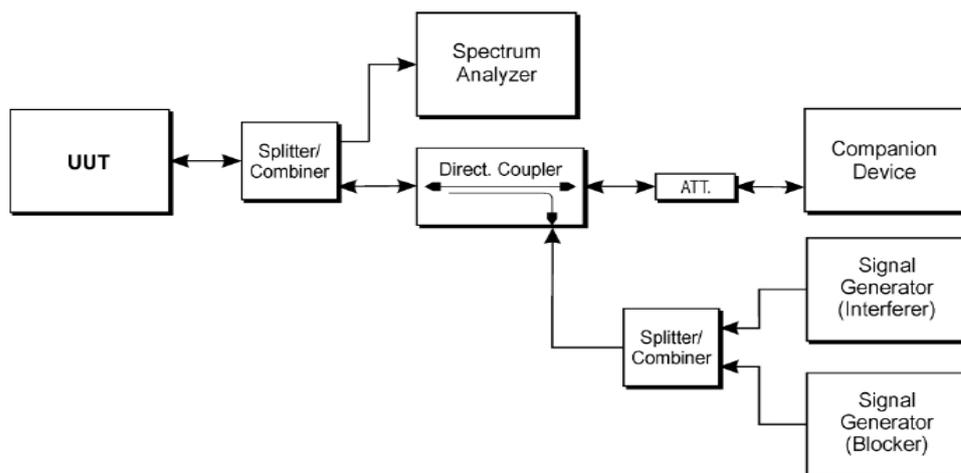

### 5.3 Test Procedure

Refer to ETSI EN 300 328 V2.1.1 (2016-11) Clause 5.3.7.

#### Step 1:

The UUT may connect to a companion device during the test. The interference signal generator, the blocking signal generator, the spectrum analyser, the UUT and the companion device are connected using a set-up equivalent to the example given by figure 5 although the interference and blocking signal generator do not generate any signals at



this point in time. The spectrum analyser is used to monitor the transmissions of the UUT in response to the interfering and the blocking signals.

Adjust the received signal level (wanted signal from the companion device) at the UUT to the value defined in table 6

The analyzer shall be set as follows:

- RBW:  $\geq$  Occupied Channel Bandwidth (if the analyser does not support this setting, the highest available setting shall be used)
- VBW:  $3 \times$  RBW (if the analyser does not support this setting, the highest available setting shall be used)
- Detector Mode: RMS
- Centre Frequency: Equal to the centre frequency of the operating channel
- Span: 0 Hz
- Sweep time:  $>$  Channel Occupancy Time of the UUT
- Trace Mode: Clear/Write
- Trigger Mode: Video

**Step 2:**

Configure the UUT for normal transmissions with a sufficiently high payload to allow demonstration of compliance of the adaptive mechanism on the channel being tested. Using the procedure defined in clause 5.3.7.2.1.4, it shall be verified that the UUT complies with the maximum Channel Occupancy Time and minimum Idle Period.

**Step 3: Adding the interference signal**

A 100 % duty cycle interference signal is injected on the current operating channel of the UUT. This interference signal shall be a band limited noise signal which has a flat power spectral density, and shall have a bandwidth greater than the Occupied Channel Bandwidth of the UUT. The maximum ripple of this interfering signal shall be  $\pm 1,5$  dB within the Occupied Channel Bandwidth and the power spectral density.

**Step 4: Verification of reaction to the interference signal**

The spectrum analyser shall be used to monitor the transmissions of the UUT on the selected operating channel with the interfering signal injected. This may require the spectrum analyser sweep to be triggered by the start of the interfering signal.

Using the procedure defined in clause 5.3.7.2.1.4, it shall be verified that:

The UUT shall stop transmissions on the current operating channel being tested.

Apart from Short Control Signalling Transmissions (see iii) below), there shall be no subsequent transmissions on this operating channel for a (silent) period defined in clause 4.3.2.5.1.2 step 2. After that, the UUT may have normal transmissions again for the duration of a single Channel Occupancy Time period. Because the interference signal is still present, another silent period as defined in clause 4.3.2.5.1.2 step 2 needs to be included. This sequence is repeated as long as the interfering signal is present.

The UUT may continue to have Short Control Signalling Transmissions on the operating channel while the interference signal is present. These transmissions shall comply with the limits

Alternatively, the equipment may switch to a non-adaptive mode

**Step 5: Adding the blocking signal**

With the interfering signal present, a 100 % duty cycle CW signal is inserted as the blocking signal

Repeat step 4 to verify that the UUT does not resume any normal transmissions

**Step 6: Removing the interference and blocking signal**



On removal of the interference and blocking signal the UUT is allowed to start transmissions again on this channel however, it shall be verified that this shall only be done after the period defined in clause 4.3.2.5.1.2 step 2.

**Step 7:**

The steps 2 to 6 shall be repeated for each of the frequencies to be tested.

5.4 Test Result

Test mode	Stop time after interfering signal(ms)	
Channel	Low	High
802.11b mode	267.25	322.18
802.11g mode	365.28	322.25
802.11n HT20 mode	281.36	322.26

Remark: 1: Short Control Signalling Transmissions of adaptive equipment using wide band modulations other than FHSS shall have a maximum duty cycle of 10 % within an observation period of 50 ms.

Short Control Signalling Transmissions						
Test mode	Channel	Channel occupancy time (ms)	Idle time (ms)	Pulse width (ms)	Maximum duty cycle(%)	Conclusion
802.11b mode	Low	1.55	0.05	1.425	2.85	Pass
	High	1.27	0.05	1.225	2.45	Pass
802.11g mode	Low	1.25	0.05	1.225	2.45	Pass
	High	1.27	0.05	1.225	2.45	Pass
802.11n HT20 mode	Low	1.7	0.05	1.649	3.30	Pass
	High	1.27	0.05	1.225	2.45	Pass

Note:  
 1. Channel occupancy time must between on 1.65ms to 13.25ms  
 2. Idle time must longer than 20us.  
 3. Duty cycle=Pulse time/50ms.  
 4. Short Control Signalling Transmissions of adaptive equipment using wide band modulations other than FHSS shall have a maximum duty cycle of 10 % within an observation period of 50 ms.  
 5: The 802.11g/n20/n40 mode, EIRP is less than 10dBm, so the test not applicable.



802.11 b Low channel	
AWGN Interference Level (dBm)	-63.08
Blocking Interference Level (dBm)	-30
Interference Start Time (ms)	217.25
Blocking Interference Start Time(ms)	267.25
Suggest q Level	4
Max COT (ms)	1.55
Idle Time (ms)	0.050
Pulse width (ms)	1.425
Duty Cycle (%)	2.85

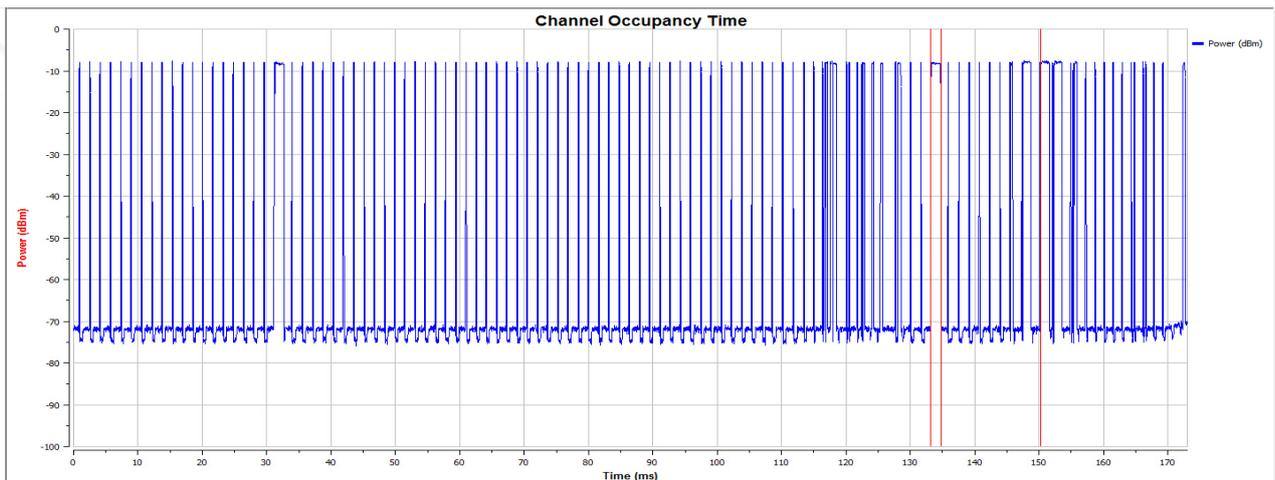
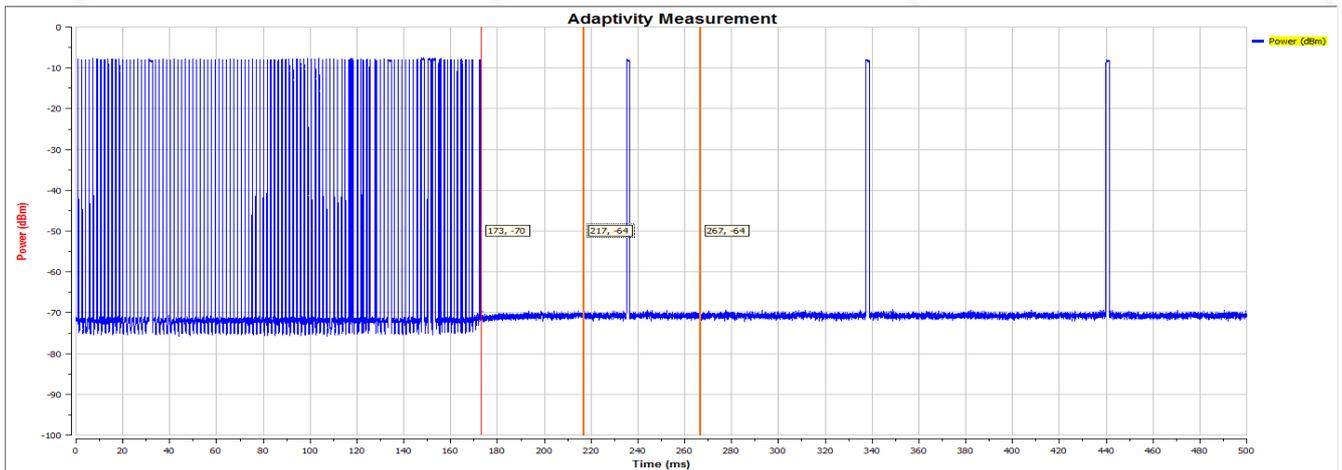

Channel Occupancy Time Info  
 Maximum Channel Occupancy Time (ms) : 1.55  
 Minimum Channel Occupancy Time (ms) : 0.00  
 \*COT Time must between on 1.625ms to 13ms  
 Idle Time (us) : 50.00  
 \*Idle Time must longer than 20us

**Suggested q Number : 4**

**Idle Time / Max COT (%) : 3.23**



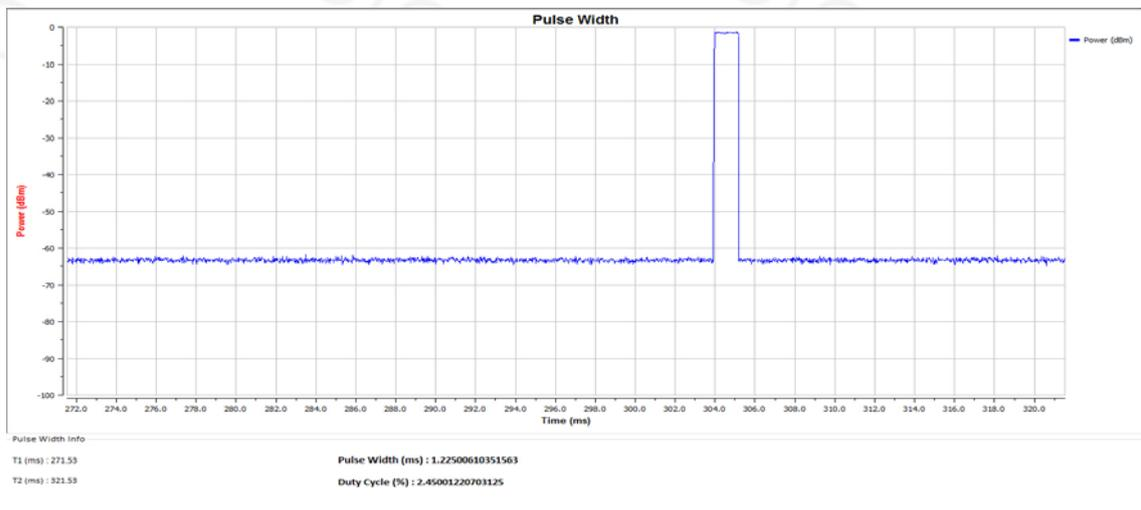
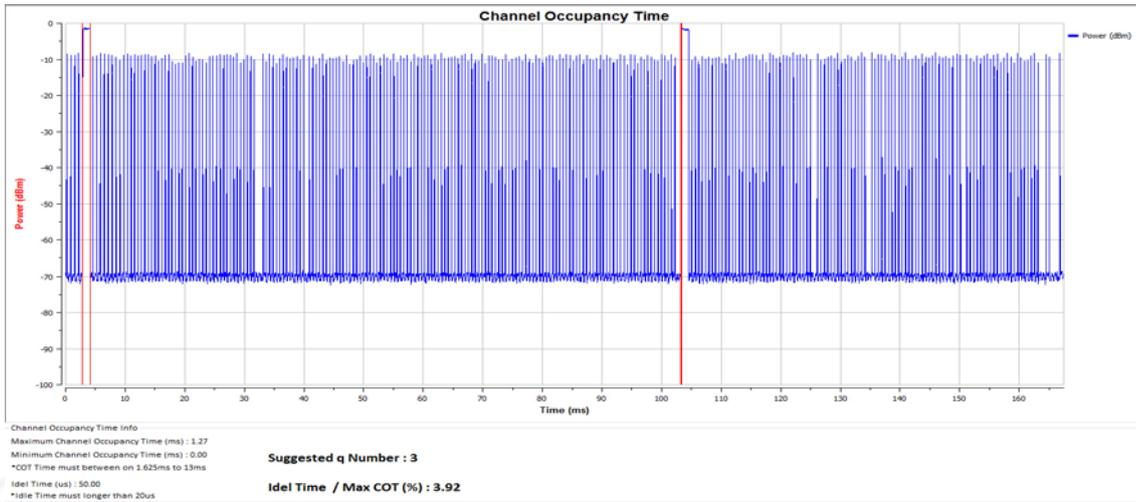

802.11g Low channel	
<b>AWGN Interference Level (dBm)</b>	-63.85
<b>Blocking Interference Level (dBm)</b>	-30
<b>Interference Start Time (ms)</b>	315.28
<b>Blocking Interference Start Time(ms)</b>	365.28
<b>Suggest q Level</b>	3
<b>Max COT (ms)</b>	1.25
<b>Idle Time (ms)</b>	0.050
<b>Pulse width (ms)</b>	1.225
<b>Duty Cycle (%)</b>	2.45

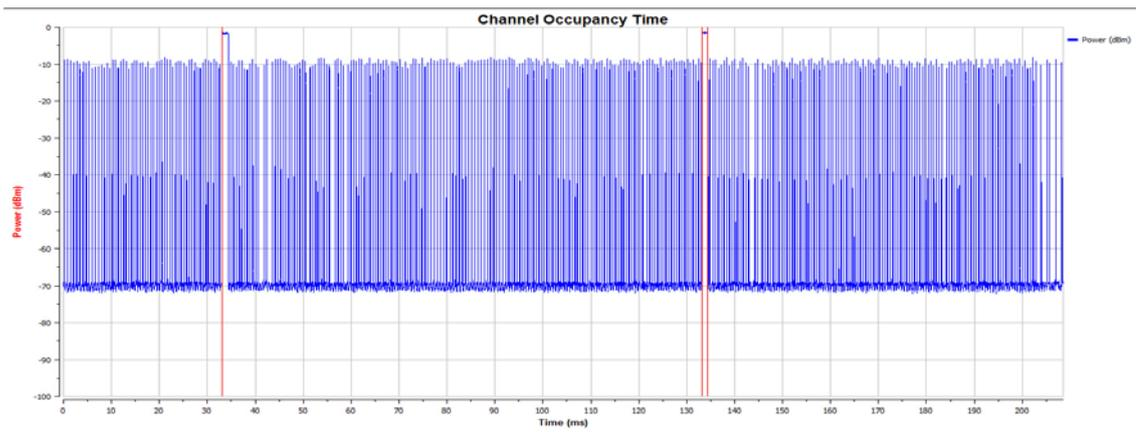
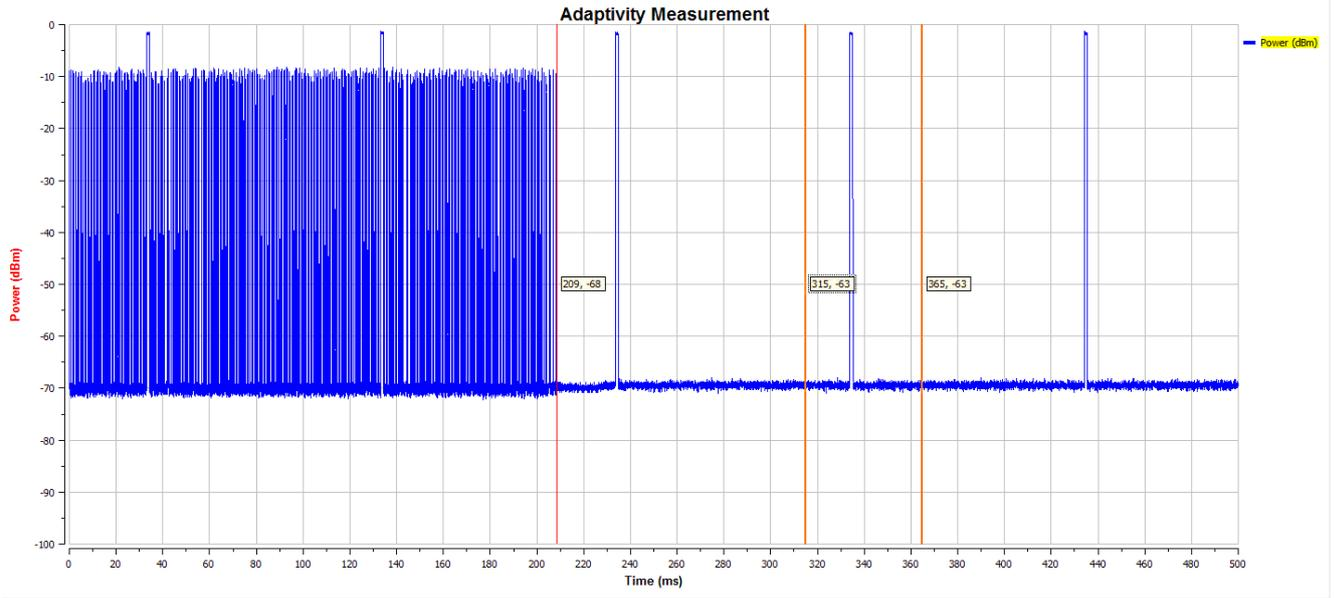

Channel Occupancy Time Info

- Maximum Channel Occupancy Time (ms) : 1.23
- Minimum Channel Occupancy Time (ms) : 0.00
- \*COT Time must between on 1.625ms to 13ms
- Idle Time (us) : 50.00
- \*Idle Time must longer than 20us

**Suggested q Number : 3**

**Idle Time / Max COT (%) : 4.08**

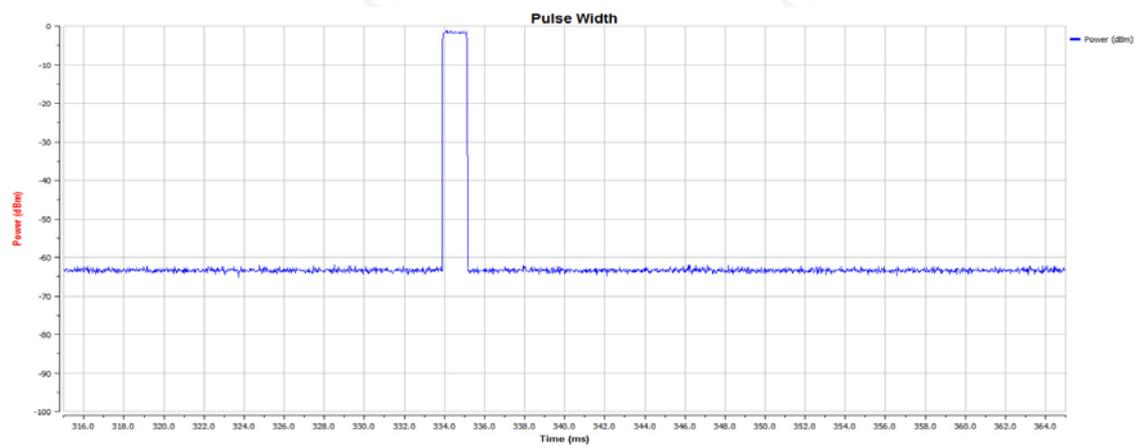

Pulse Width Info

- T1 (ms) : 314.99
- T2 (ms) : 364.99
- Pulse Width (ms) : 1.22500610351563
- Duty Cycle (%) : 2.45001220703125



802.11 g High channel	
<b>AWGN Interference Level (dBm)</b>	-63.66
<b>Blocking Interference Level (dBm)</b>	-30
<b>Interference Start Time (ms)</b>	272.25
<b>Blocking Interference Start Time(ms)</b>	322.25
<b>Suggest q Level</b>	3
<b>Max COT (ms)</b>	1.27
<b>Idle Time (ms)</b>	0.050
<b>Pulse width (ms)</b>	1.225
<b>Duty Cycle (%)</b>	2.45

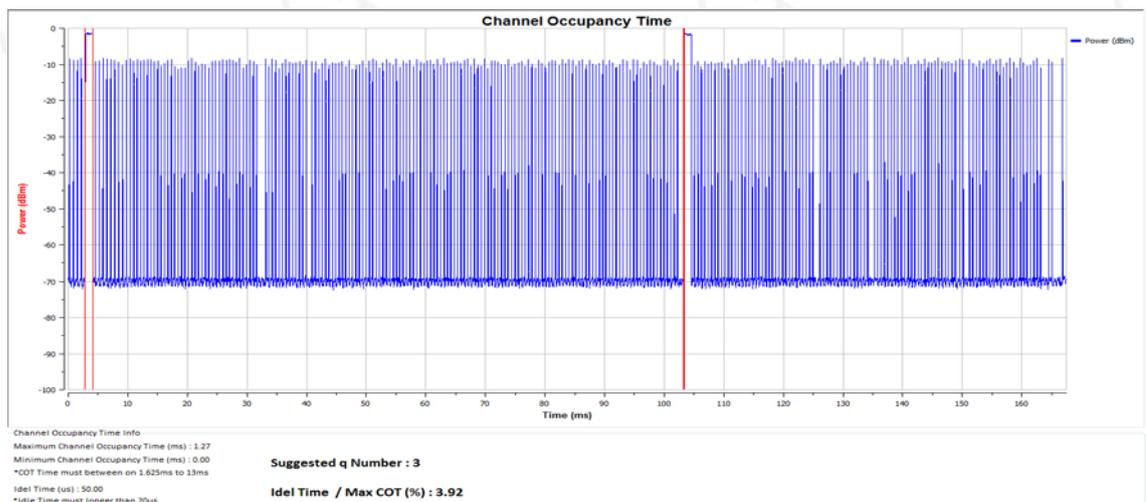
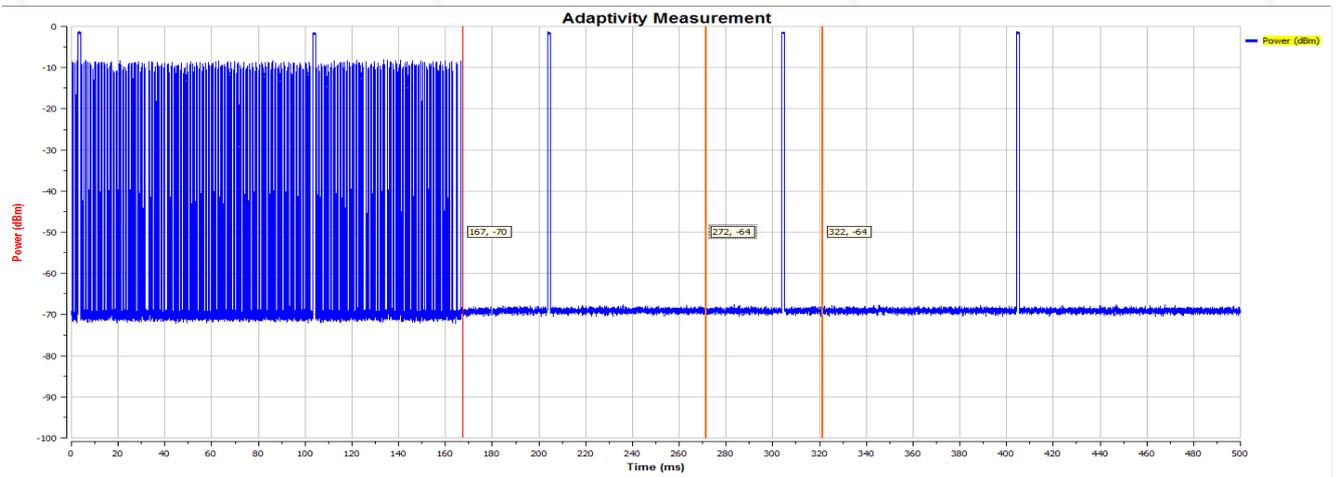

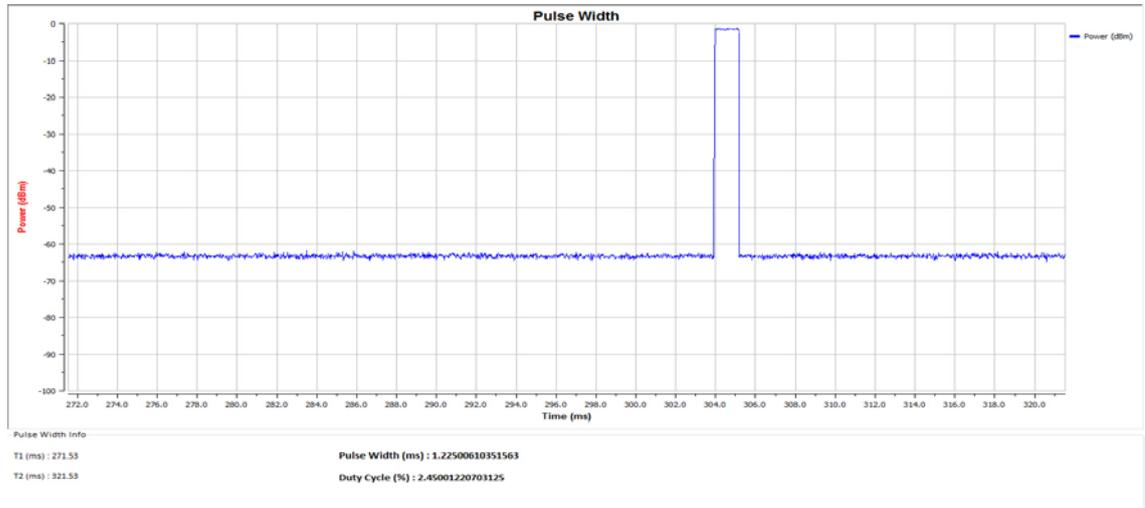

802.11n/HT20 Low channel	
AWGN Interference Level (dBm)	-61.39
Blocking Interference Level (dBm)	-30
Interference Start Time (ms)	231.36
Blocking Interference Start Time(ms)	281.36
Suggest q Level	3
Max COT (ms)	1.70
Idle Time (ms)	0.050
Pulse width (ms)	1.649
Duty Cycle (%)	3.30

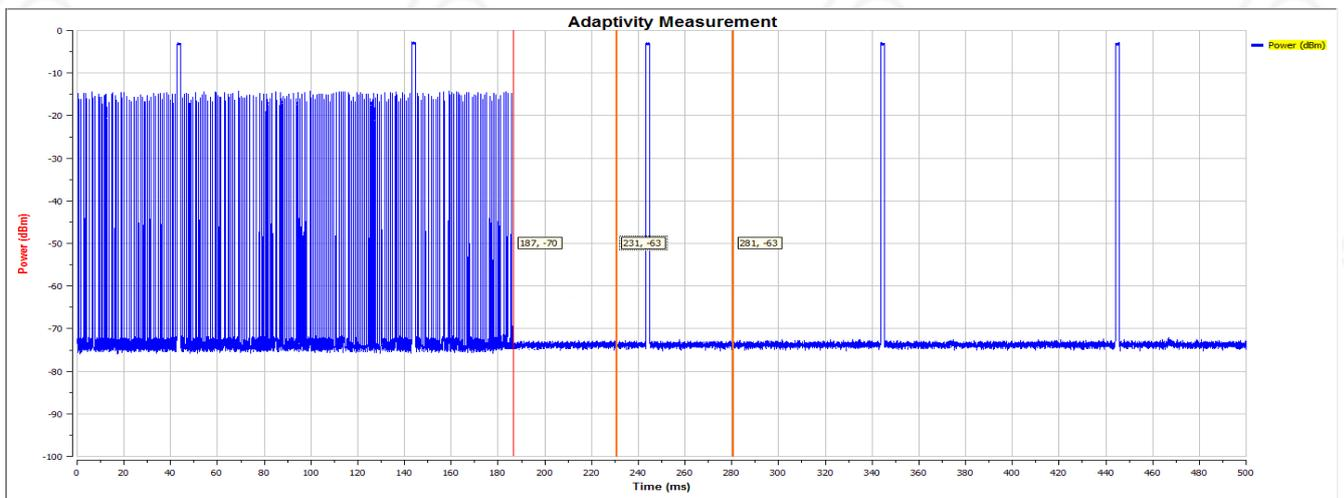

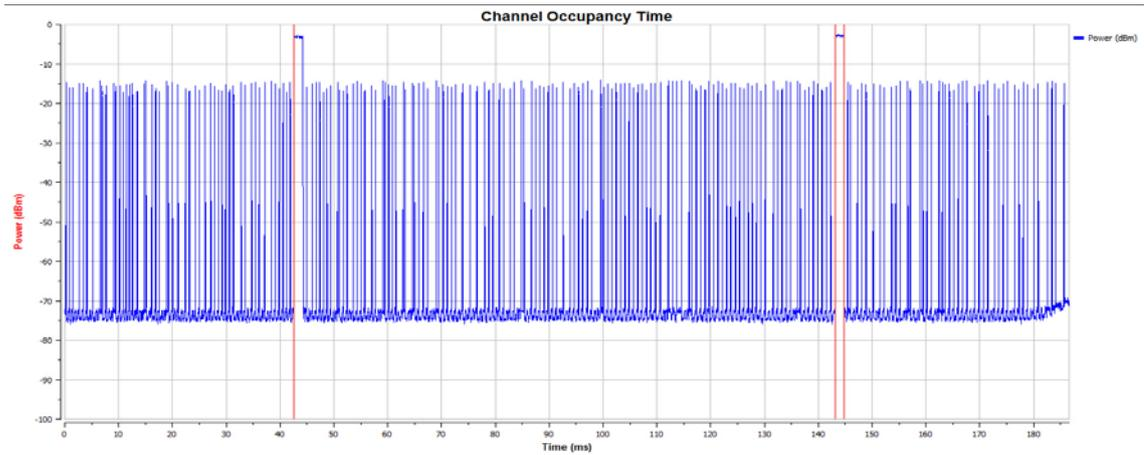

Channel Occupancy Time Info  
 Maximum Channel Occupancy Time (ms) : 1.70  
 Minimum Channel Occupancy Time (ms) : 0.00  
 \*COT Time must between on 1.625ms to 13ms  
 Idle Time (us) : 50.00  
 \*Idle Time must longer than 20us

**Suggested q Number : 4**  
**Idle Time / Max COT (%) : 2.94**

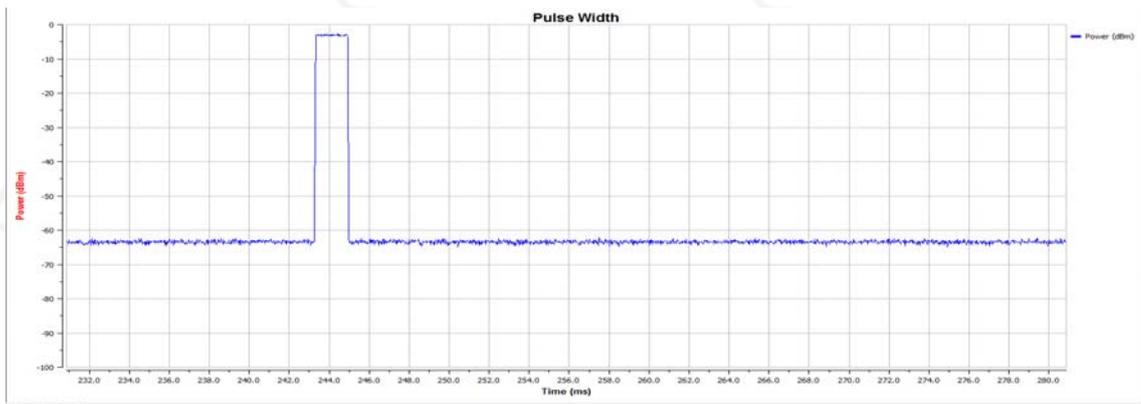

Pulse Width Info  
 T1 (ms) : 230.86  
 T2 (ms) : 280.86  
 Pulse Width (ms) : 1.64999389648438  
 Duty Cycle (%) : 3.29998779296875

0.05

802.11 n/HT20 High channel	
<b>AWGN Interference Level (dBm)</b>	-63.95
<b>Blocking Interference Level (dBm)</b>	-30
<b>Interference Start Time (ms)</b>	272.26
<b>Blocking Interference Start Time(ms)</b>	322.26
<b>Suggest q Level</b>	3
<b>Max COT (ms)</b>	1.27
<b>Idle Time (ms)</b>	0.050
<b>Pulse width (ms)</b>	1.225
<b>Duty Cycle (%)</b>	2.45

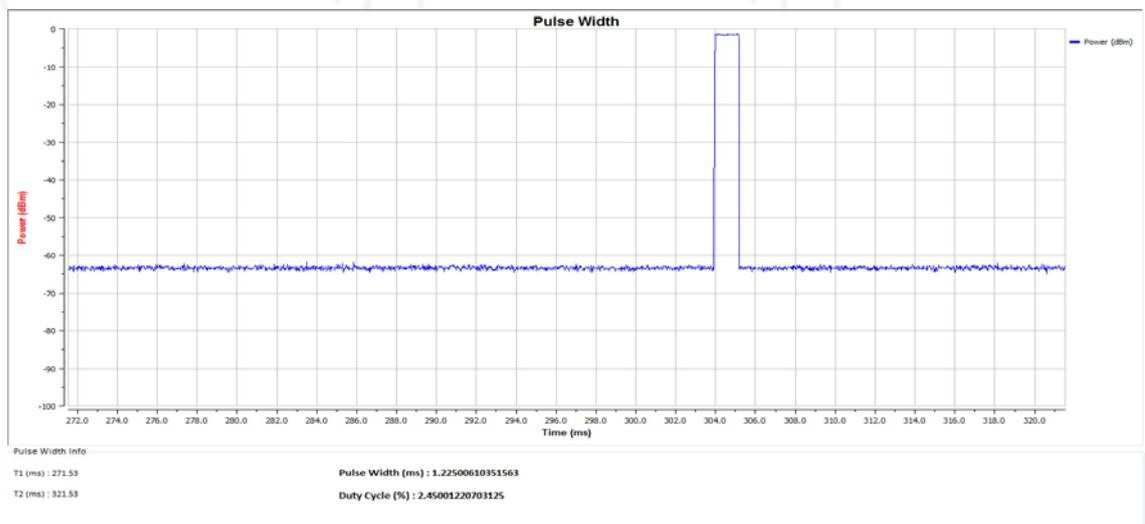
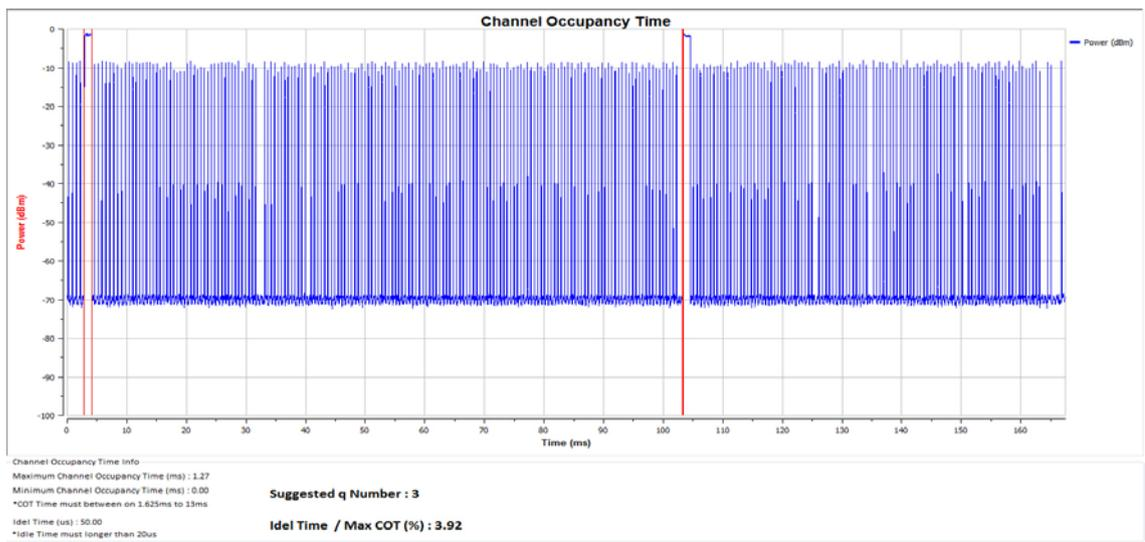
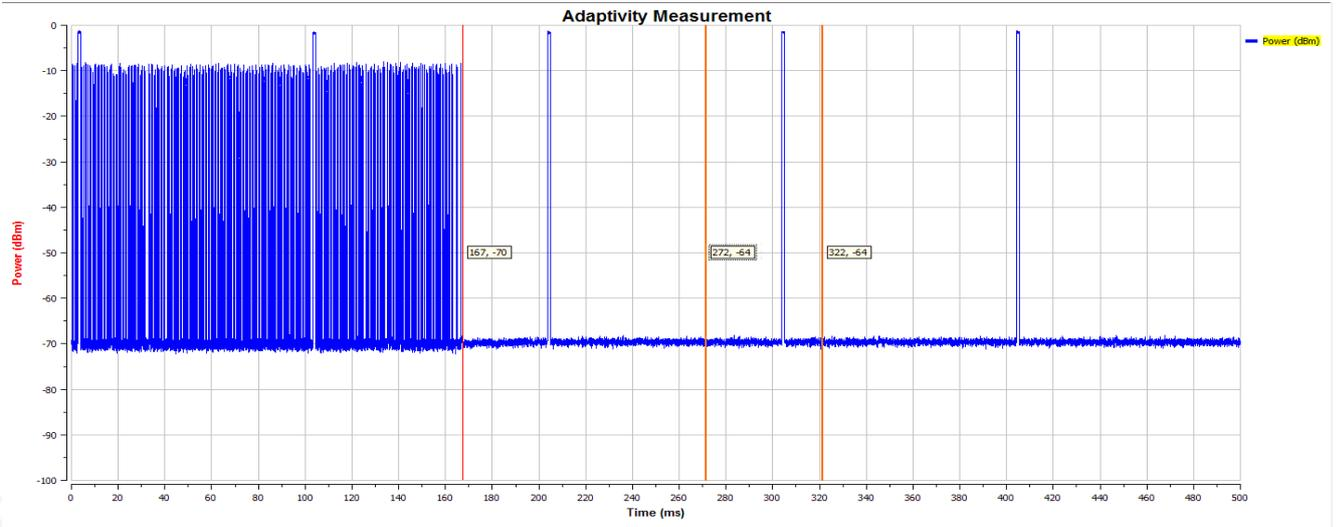



## 6. Occupied Channel Bandwidth

### 6.1 Limit

The Occupied Channel Bandwidth shall fall completely within the band given in 2.4GHz to 2.4835GHz.

In addition, for non-adaptive systems using wide band modulations other than FHSS and with e.i.r.p greater than 10 dBm, the occupied channel bandwidth shall be less than 20 MHz.

### 6.2 Test Setup

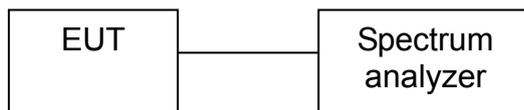

### 6.3 Test Procedure

Refer to ETSI EN 300 328 V2.1.1 (2016-11) Clause 5.230.

Connect the UUT to the spectrum analyzer and use the following settings:

Centre Frequency	The centre frequency of the channel under test
Frequency Span	2 × Occupied Channel Bandwidth (e.g. 40 MHz for a 20 MHz channel)
RBW	~ 1 % of the span without going below 1 % (430 KHz, 820KHz)
VBW	3 × RBW (1.2MHz; 2.4MHz)
Detector	RMS
Trace	Max hold



6.4 Test Result

EUT: Sonoff WiFi smart switch	M/N: Sonoff RF
Test site: RF site	

Frequency Rang			
Test mode	CH	Result	Limit
		MHz	MHz
802.11 B	CH1	2406.341	>2400.0
	CH13	2477.865	<2483.5
802.11 G	CH1	2403.673	>2400.0
	CH13	2480.362	<2483.5
802.11 N20	CH1	2403.056	>2400.0
	CH13	2481.033	<2483.5
Test Result: PASS.			

Occupied Bandwidth		
Test mode	Occupied Bandwidth (MHz)	
	Lowest frequency	Highest fequency
802.11 B	11.354	11.719
802.11 G	16.683	16.700
802.11 N20	17.976	17.986
Test Result: PASS.		



Occupied Band Width (MHz)	11.354	802.11b CH Low-2412
---------------------------	--------	---------------------

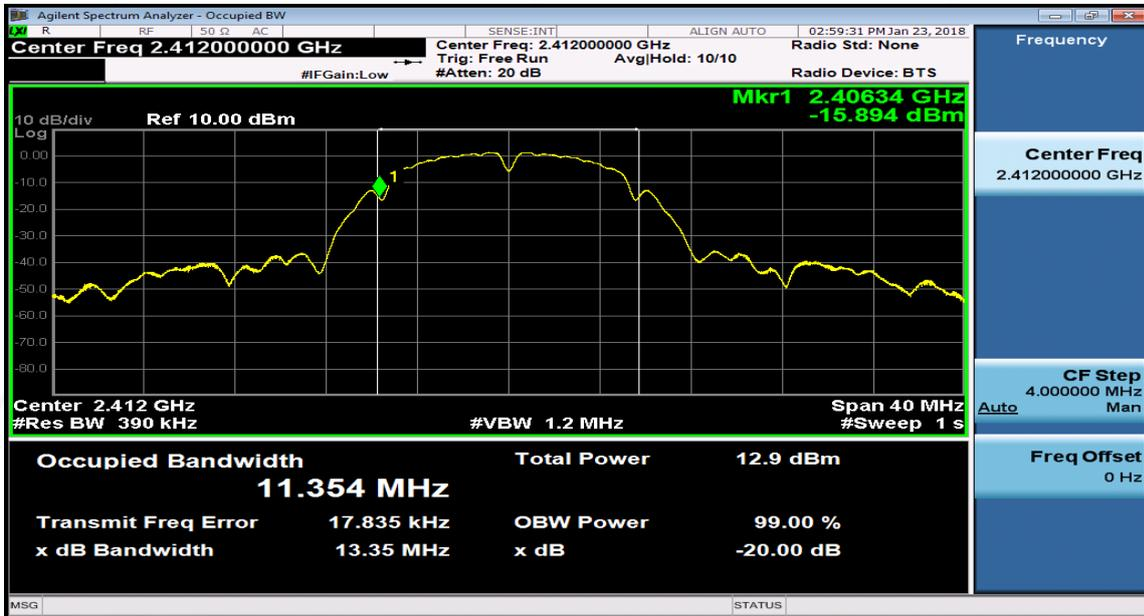

Occupied Band Width (MHz)	11.719	802.11b CH High-2472
---------------------------	--------	----------------------

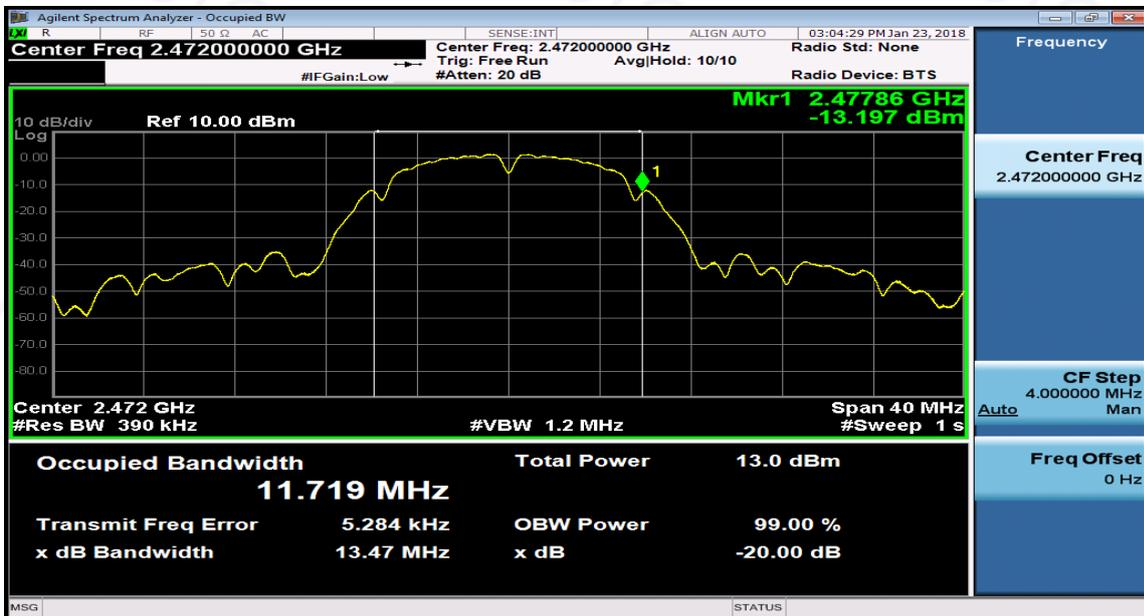



Occupied Band Width (MHz)	16.683	802.11g CH Low-2412
---------------------------	--------	---------------------

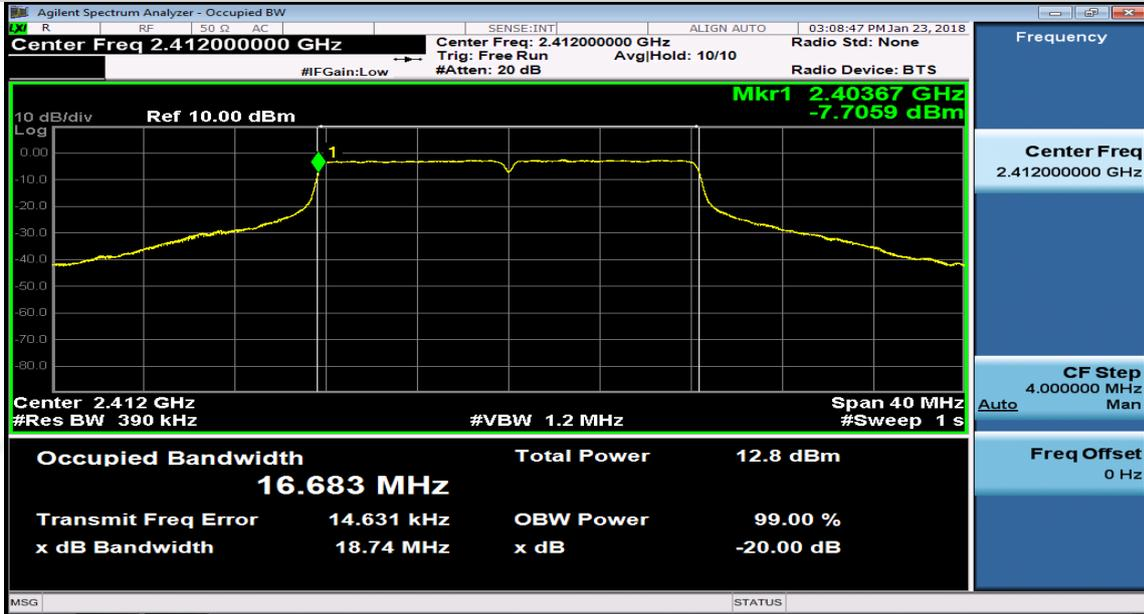

Occupied Band Width (MHz)	16.700	802.11g CH High-2472
---------------------------	--------	----------------------

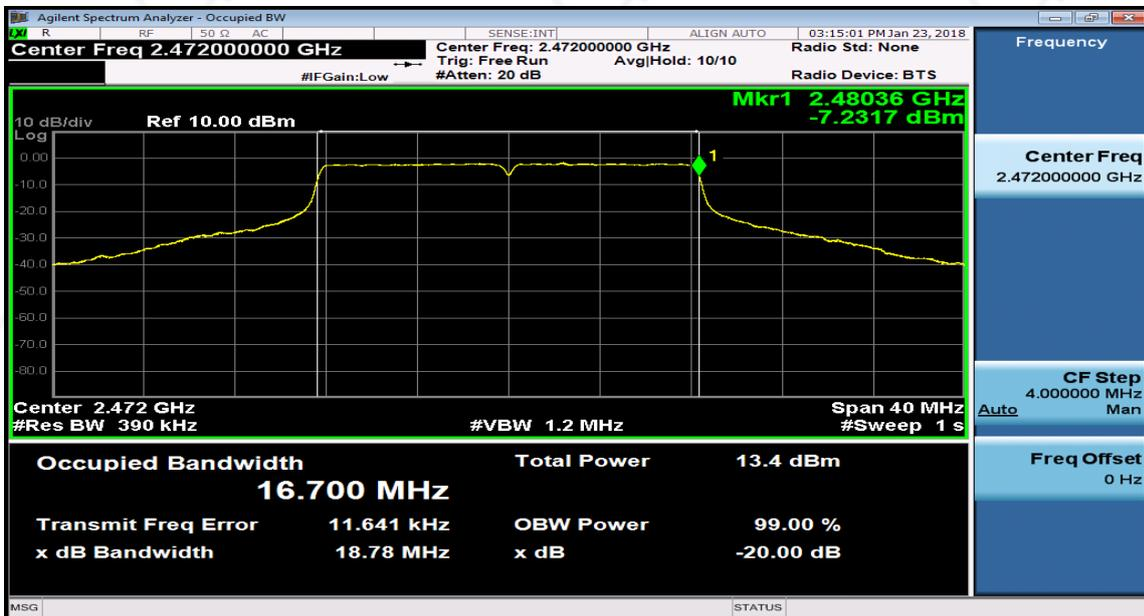



Occupied Band Width (MHz)	17.976	802.11n20 CH Low-2412
---------------------------	--------	-----------------------

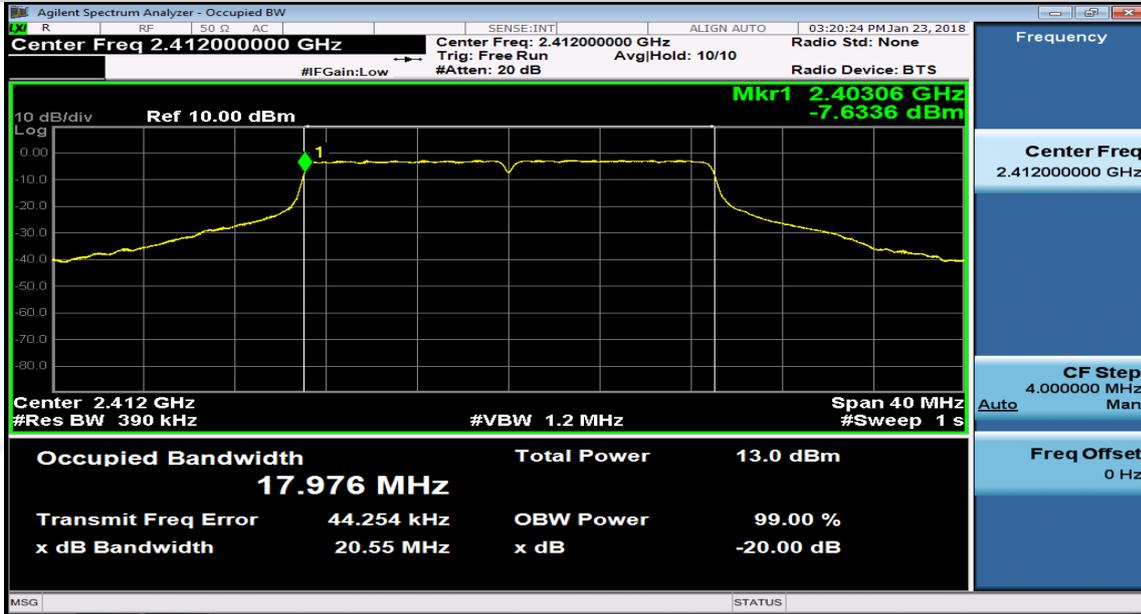

Occupied Band Width (MHz)	17.986	802.11n20 CH High-2472
---------------------------	--------	------------------------

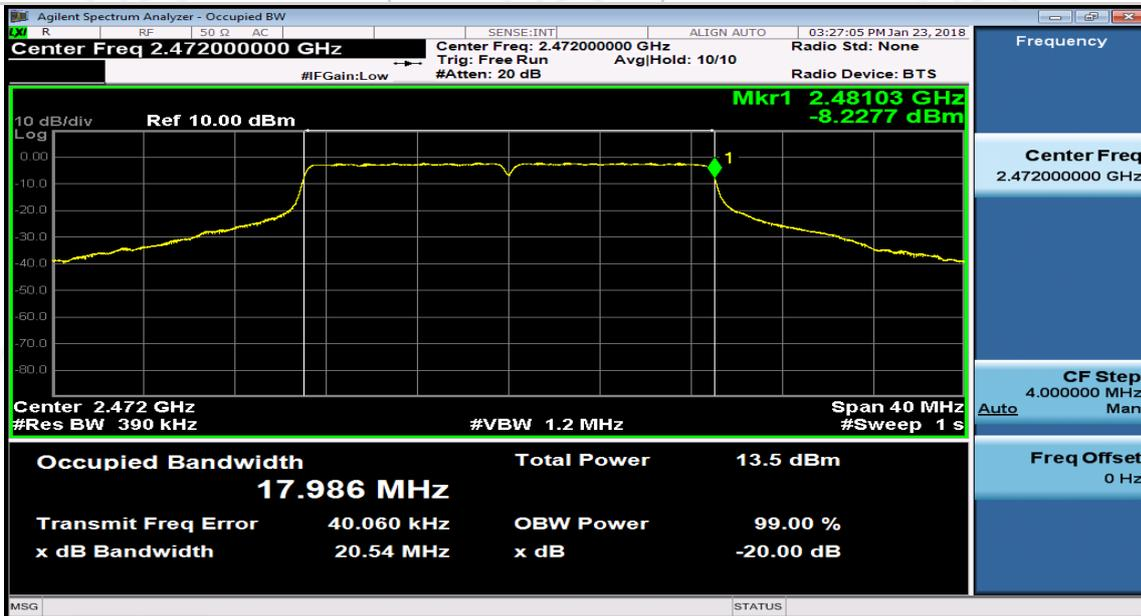

## 7. Transmitter unwanted emissions in the out-of-band domain

### 7.1 Limit

The transmitter unwanted emissions in the out-of-band domain but outside the allocated band, shall not exceed the values provided by the mask in figure 3.

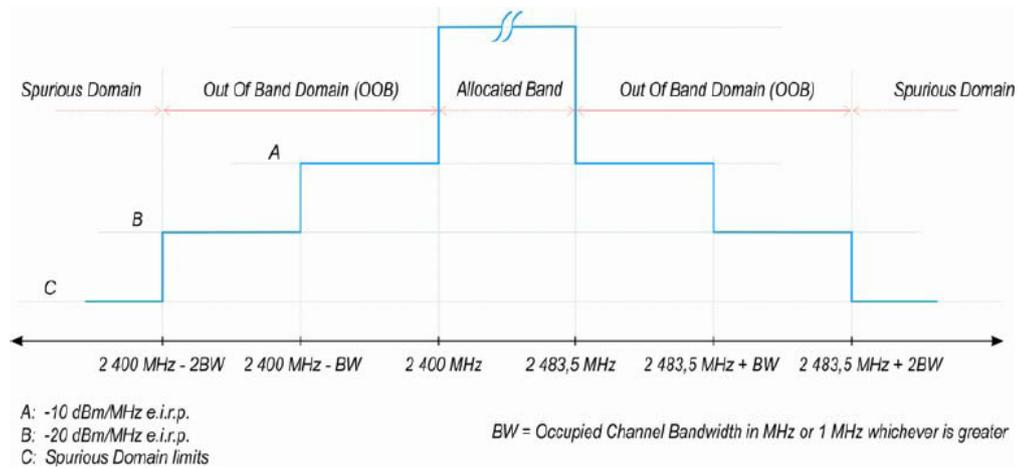
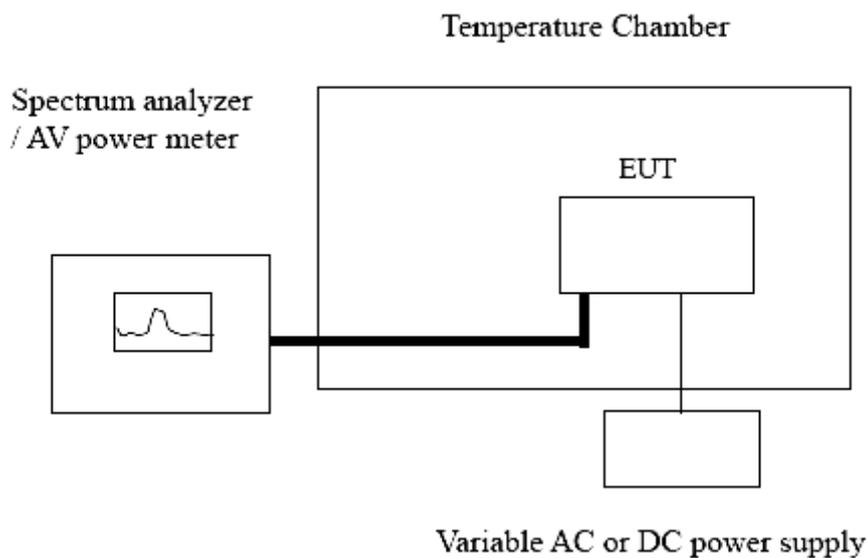

Figure 3: Transmit mask

### 7.2 Test Setup





### 7.3 Test Procedure

Refer to ETSI EN 300 328 V2.1.1 (2016-11) Clause 5.3.9.

Connect the UUT to the spectrum analyzer and use the following settings:

RBW/ VBW	1MHz/3MHz
Span	0Hz
Filter mode	Channel filter
Sweep mode	Continuous
Sweep Points	5000
Detector	RMS
Trace mode	Clear / Write
Trigger Mode	Video trigger

### 7.4 Test Result

Test Condition			Lower Band Edge		Higher Band Edge	
Test Mode	Temp	Voltage	Segment A (dBm/MHz)	Segment B (dBm/MHz)	Segment A (dBm/MHz)	Segment B (dBm/MHz)
802.11 B	Normal	Normal	-45.98	-54.87	-39.98	-49.31
	55°C	207	-46.50	-55.49	-40.43	-49.86
	55°C	253	-46.59	-55.60	-40.51	-49.97
	-20°C	207	-46.63	-55.64	-40.54	-50.56
	-20°C	253	-46.63	-55.64	-40.54	-50.00
Limit			-10	-20	-10	-20
Conclusion			PASS			



Test Condition			Lower Band Edge		Higher Band Edge	
Test Mode	Temp	Voltage	Segment A (dBm/MHz)	Segment B (dBm/MHz)	Segment A (dBm/MHz)	Segment B (dBm/MHz)
802.11 G	Normal	Normal	-23.8	-45.32	-21.65	-45.25
	55°C	207	-24.07	-45.83	-21.89	-45.76
	55°C	253	-24.12	-45.92	-21.94	-45.85
	-20°C	207	-24.14	-45.96	-21.95	-50.56
	-20°C	253	-24.14	-45.96	-21.95	-45.89
Limit			-10	-20	-10	-20
Conclusion			PASS			
Remark: All modulations of EUT have been tested, but only show the test data of the worst case in this report.						

Test Condition			Lower Band Edge		Higher Band Edge	
Test Mode	Temp	Voltage	Segment A (dBm/MHz)	Segment B (dBm/MHz)	Segment A (dBm/MHz)	Segment B (dBm/MHz)
802.11 N20	Normal	Normal	-22.72	-44.81	-20.1	-45.26
	55°C	207	-22.98	-45.31	-20.33	-45.77
	55°C	253	-23.02	-45.41	-20.37	-45.86
	-20°C	207	-23.04	-45.44	-20.38	-50.56
	-20°C	253	-23.04	-45.44	-20.38	-45.90
Limit			-10	-20	-10	-20
Conclusion			PASS			
Remark: All modulations of EUT have been tested, but only show the test data of the worst case in this report.						

**802.11 b CH Low (Normal Temp, Normal Voltage)**

Test Freq (MHz)	Antenna	Freq(MHz)	Level	Limit
2412	Antenna 1	2399.5	-45.98	-10
2412	Antenna 1	2398.5	-42.6	-10
2412	Antenna 1	2397.5	-43.48	-10
2412	Antenna 1	2396.5	-46.63	-10
2412	Antenna 1	2395.5	-51.15	-10
2412	Antenna 1	2394.5	-55.42	-10
2412	Antenna 1	2393.5	-55.87	-10
2412	Antenna 1	2392.5	-55.75	-10
2412	Antenna 1	2391.5	-54.61	-10
2412	Antenna 1	2390.5	-56.3	-10
2412	Antenna 1	2389.5	-56.24	-10
2412	Antenna 1	2389.146	-56.34	-10
2412	Antenna 1	2388.146	-54.87	-20
2412	Antenna 1	2387.146	-54.76	-20
2412	Antenna 1	2386.146	-55.26	-20
2412	Antenna 1	2385.146	-54.11	-20
2412	Antenna 1	2384.146	-53.8	-20
2412	Antenna 1	2383.146	-55.69	-20
2412	Antenna 1	2382.146	-56.51	-20
2412	Antenna 1	2381.146	-56.64	-20
2412	Antenna 1	2380.146	-56.34	-20
2412	Antenna 1	2379.146	-56.63	-20
2412	Antenna 1	2378.146	-57.07	-20
2412	Antenna 1	2377.792	-57.08	-20

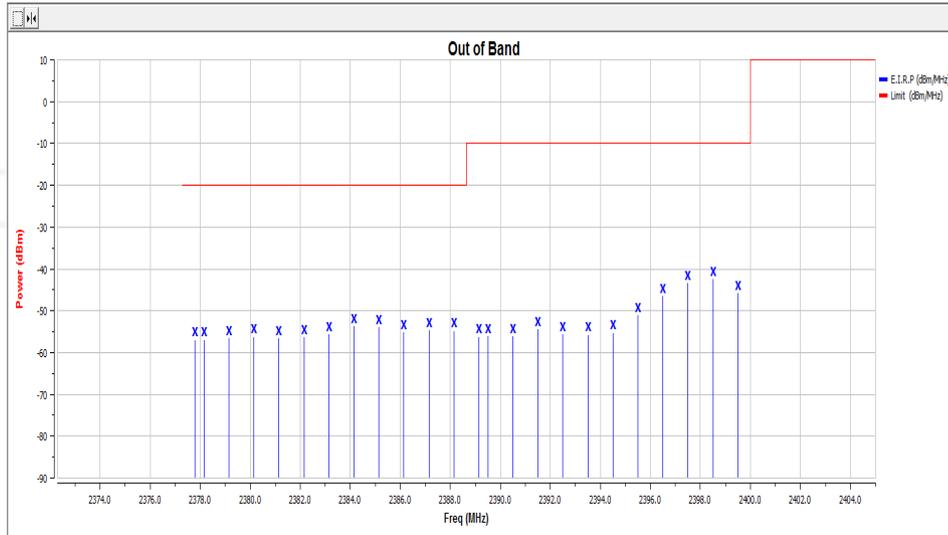

**802.11 b CH High (Normal Temp, Normal Voltage)**

Test Freq (MHz)	Antenna	Freq(MHz)	Level	Limit
2472	Antenna 1	2484	-39.98	-10
2472	Antenna 1	2485	-37.04	-10
2472	Antenna 1	2486	-37.57	-10
2472	Antenna 1	2487	-39.44	-10
2472	Antenna 1	2488	-41.59	-10
2472	Antenna 1	2489	-44.91	-10
2472	Antenna 1	2490	-47.32	-10
2472	Antenna 1	2491	-51.51	-10
2472	Antenna 1	2492	-47.27	-10
2472	Antenna 1	2493	-48.67	-10
2472	Antenna 1	2494	-53.08	-10
2472	Antenna 1	2494.719	-51.25	-10
2472	Antenna 1	2495.719	-49.31	-20
2472	Antenna 1	2496.719	-46.26	-20
2472	Antenna 1	2497.719	-50.07	-20
2472	Antenna 1	2498.719	-50.62	-20
2472	Antenna 1	2499.719	-51.37	-20
2472	Antenna 1	2500.719	-51.32	-20
2472	Antenna 1	2501.719	-52.23	-20
2472	Antenna 1	2502.719	-53.78	-20
2472	Antenna 1	2503.719	-50.93	-20
2472	Antenna 1	2504.719	-53.64	-20
2472	Antenna 1	2505.719	-55.78	-20
2472	Antenna 1	2506.438	-55.67	-20

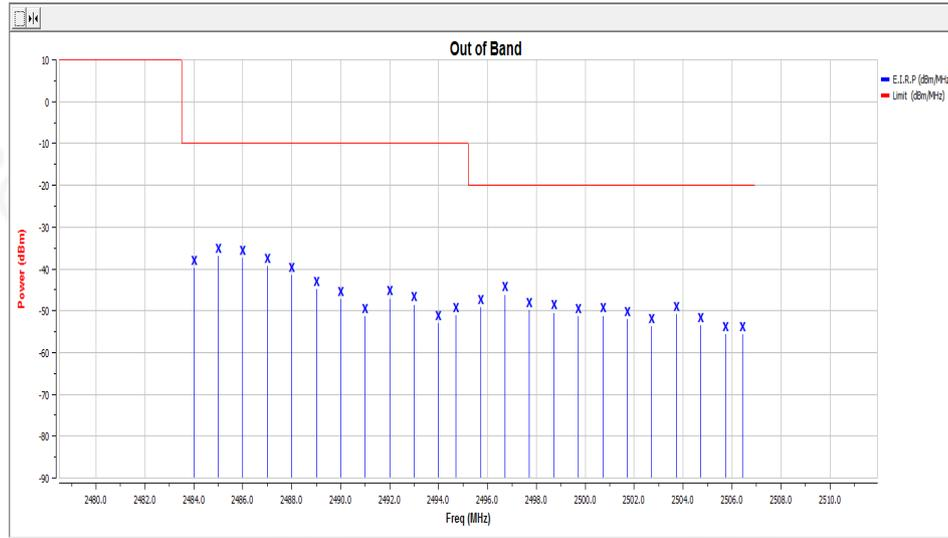

**802.11 g CH Low (Normal Temp, Normal Voltage)**

Test Freq (MHz)	Antenna	Freq(MHz)	Level	Limit
2412	Antenna 1	2399.5	-23.8	-10
2412	Antenna 1	2398.5	-25.01	-10
2412	Antenna 1	2397.5	-27.1	-10
2412	Antenna 1	2396.5	-29.16	-10
2412	Antenna 1	2395.5	-31.37	-10
2412	Antenna 1	2394.5	-33.13	-10
2412	Antenna 1	2393.5	-34.7	-10
2412	Antenna 1	2392.5	-35.98	-10
2412	Antenna 1	2391.5	-36.96	-10
2412	Antenna 1	2390.5	-39.18	-10
2412	Antenna 1	2389.5	-40.48	-10
2412	Antenna 1	2388.5	-42.05	-10
2412	Antenna 1	2387.5	-43.18	-10
2412	Antenna 1	2386.5	-43.8	-10
2412	Antenna 1	2385.5	-44.1	-10
2412	Antenna 1	2384.5	-44.57	-10
2412	Antenna 1	2383.817	-44.97	-10
2412	Antenna 1	2382.817	-45.32	-20
2412	Antenna 1	2381.817	-45.71	-20
2412	Antenna 1	2380.817	-46.02	-20
2412	Antenna 1	2379.817	-46.48	-20
2412	Antenna 1	2378.817	-46.42	-20
2412	Antenna 1	2377.817	-46.9	-20
2412	Antenna 1	2376.817	-47.16	-20
2412	Antenna 1	2375.817	-47.91	-20
2412	Antenna 1	2374.817	-48.07	-20
2412	Antenna 1	2373.817	-48.46	-20
2412	Antenna 1	2372.817	-48.86	-20
2412	Antenna 1	2371.817	-48.94	-20
2412	Antenna 1	2370.817	-49.23	-20
2412	Antenna 1	2369.817	-49.25	-20
2412	Antenna 1	2368.817	-49.48	-20
2412	Antenna 1	2367.817	-49.67	-20
2412	Antenna 1	2367.134	-49.89	-20

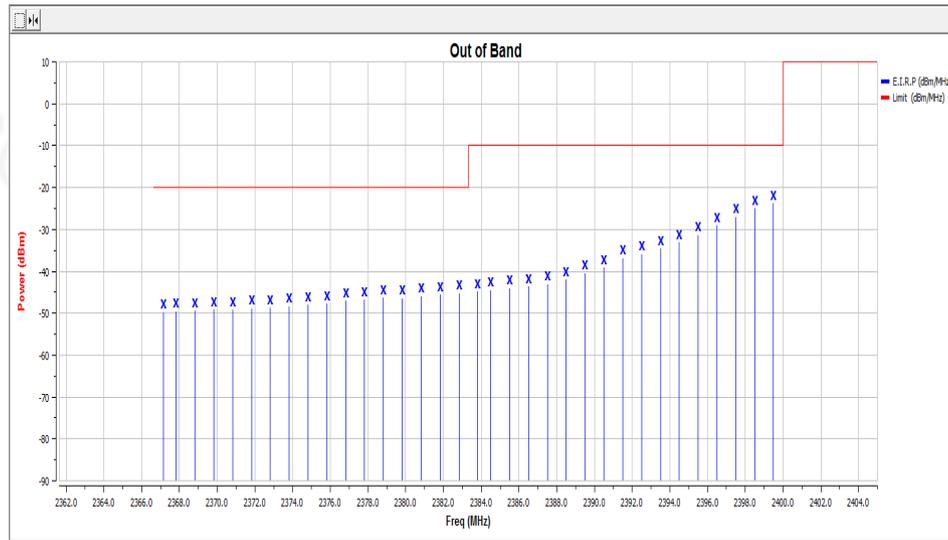

**802.11 g CH High (Normal Temp, Normal Voltage)**

Test Freq (MHz)	Antenna	Freq(MHz)	Level	Limit
2472	Antenna 1	2484	-21.65	-10
2472	Antenna 1	2485	-23.3	-10
2472	Antenna 1	2486	-24.73	-10
2472	Antenna 1	2487	-26.34	-10
2472	Antenna 1	2488	-28.44	-10
2472	Antenna 1	2489	-31	-10
2472	Antenna 1	2490	-32.33	-10
2472	Antenna 1	2491	-33.66	-10
2472	Antenna 1	2492	-34.86	-10
2472	Antenna 1	2493	-36.72	-10
2472	Antenna 1	2494	-38.82	-10
2472	Antenna 1	2495	-40.61	-10
2472	Antenna 1	2496	-42.27	-10
2472	Antenna 1	2497	-43.44	-10
2472	Antenna 1	2498	-44.1	-10
2472	Antenna 1	2499	-44.23	-10
2472	Antenna 1	2499.7	-44.57	-10
2472	Antenna 1	2500.7	-45.25	-20
2472	Antenna 1	2501.7	-45.69	-20
2472	Antenna 1	2502.7	-46.08	-20
2472	Antenna 1	2503.7	-45.94	-20
2472	Antenna 1	2504.7	-46.43	-20
2472	Antenna 1	2505.7	-46.85	-20
2472	Antenna 1	2506.7	-47.25	-20
2472	Antenna 1	2507.7	-47.43	-20
2472	Antenna 1	2508.7	-47.82	-20
2472	Antenna 1	2509.7	-48	-20
2472	Antenna 1	2510.7	-48.14	-20
2472	Antenna 1	2511.7	-48.5	-20
2472	Antenna 1	2512.7	-48.7	-20
2472	Antenna 1	2513.7	-48.9	-20
2472	Antenna 1	2514.7	-49.09	-20
2472	Antenna 1	2515.7	-49.31	-20
2472	Antenna 1	2516.4	-49.29	-20

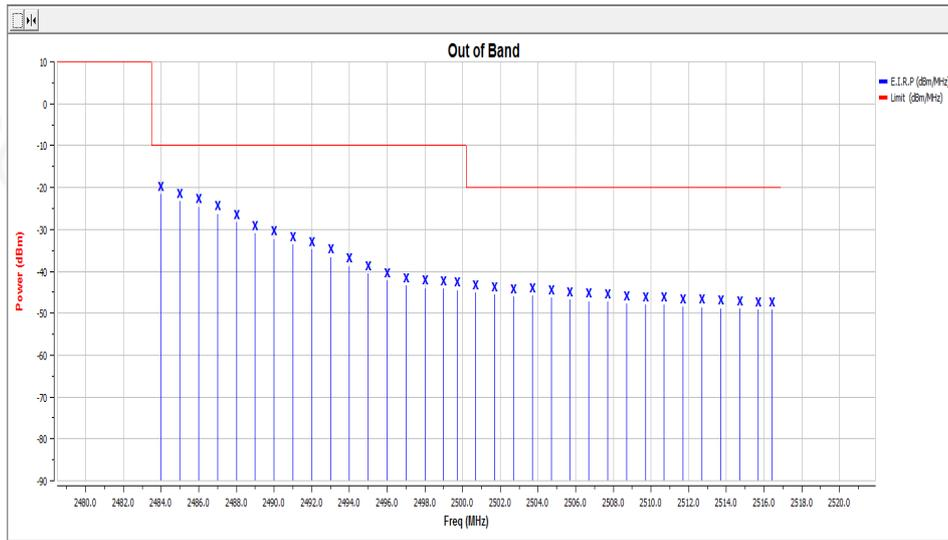

**802.11 n20 CH Low (Normal Temp, Normal Voltage)**

Test Freq (MHz)	Antenna	Freq(MHz)	Level	Limit
2412	Antenna 1	2399.5	-22.72	-10
2412	Antenna 1	2398.5	-24.37	-10
2412	Antenna 1	2397.5	-26.66	-10
2412	Antenna 1	2396.5	-28.89	-10
2412	Antenna 1	2395.5	-30.61	-10
2412	Antenna 1	2394.5	-31.97	-10
2412	Antenna 1	2393.5	-33.28	-10
2412	Antenna 1	2392.5	-35	-10
2412	Antenna 1	2391.5	-35.51	-10
2412	Antenna 1	2390.5	-36.58	-10
2412	Antenna 1	2389.5	-37.76	-10
2412	Antenna 1	2388.5	-39.26	-10
2412	Antenna 1	2387.5	-41.03	-10
2412	Antenna 1	2386.5	-42.75	-10
2412	Antenna 1	2385.5	-43.53	-10
2412	Antenna 1	2384.5	-43.8	-10
2412	Antenna 1	2383.5	-44.2	-10
2412	Antenna 1	2382.524	-44.61	-10
2412	Antenna 1	2381.524	-44.81	-20
2412	Antenna 1	2380.524	-45.38	-20
2412	Antenna 1	2379.524	-45.74	-20
2412	Antenna 1	2378.524	-45.93	-20
2412	Antenna 1	2377.524	-46.12	-20
2412	Antenna 1	2376.524	-46.81	-20
2412	Antenna 1	2375.524	-47.24	-20
2412	Antenna 1	2374.524	-47.55	-20
2412	Antenna 1	2373.524	-47.89	-20
2412	Antenna 1	2372.524	-48.2	-20
2412	Antenna 1	2371.524	-48.33	-20
2412	Antenna 1	2370.524	-48.48	-20
2412	Antenna 1	2369.524	-49.11	-20
2412	Antenna 1	2368.524	-49.02	-20
2412	Antenna 1	2367.524	-49.53	-20
2412	Antenna 1	2366.524	-49.69	-20



2412	Antenna 1	2365.524	-50.03	-20
2412	Antenna 1	2364.548	-50.12	-20

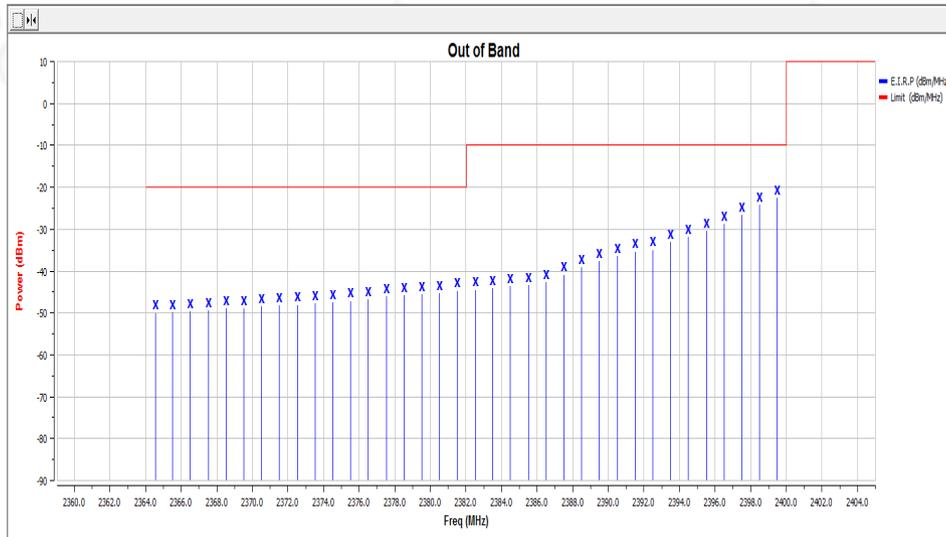

**802.11 n20 CH High (Normal Temp, Normal Voltage)**

Test Freq (MHz)	Antenna	Freq(MHz)	Level	Limit
2472	Antenna 1	2484	-20.1	-10
2472	Antenna 1	2485	-21.7	-10
2472	Antenna 1	2486	-23.38	-10
2472	Antenna 1	2487	-25.77	-10
2472	Antenna 1	2488	-28.46	-10
2472	Antenna 1	2489	-30.1	-10
2472	Antenna 1	2490	-31.13	-10
2472	Antenna 1	2491	-32.4	-10
2472	Antenna 1	2492	-33.99	-10
2472	Antenna 1	2493	-34.97	-10
2472	Antenna 1	2494	-36.18	-10
2472	Antenna 1	2495	-36.91	-10
2472	Antenna 1	2496	-39.25	-10
2472	Antenna 1	2497	-41.38	-10
2472	Antenna 1	2498	-43.18	-10
2472	Antenna 1	2499	-43.98	-10
2472	Antenna 1	2500	-44.42	-10
2472	Antenna 1	2500.986	-44.64	-10
2472	Antenna 1	2501.986	-45.26	-20
2472	Antenna 1	2502.986	-45.39	-20
2472	Antenna 1	2503.986	-45.61	-20
2472	Antenna 1	2504.986	-46.04	-20
2472	Antenna 1	2505.986	-46.33	-20
2472	Antenna 1	2506.986	-46.7	-20
2472	Antenna 1	2507.986	-47.15	-20
2472	Antenna 1	2508.986	-47.64	-20
2472	Antenna 1	2509.986	-47.81	-20
2472	Antenna 1	2510.986	-47.88	-20
2472	Antenna 1	2511.986	-48.24	-20
2472	Antenna 1	2512.986	-48.46	-20
2472	Antenna 1	2513.986	-48.66	-20
2472	Antenna 1	2514.986	-48.77	-20
2472	Antenna 1	2515.986	-48.86	-20
2472	Antenna 1	2516.986	-49.04	-20



2472	Antenna 1	2517.986	-49.34	-20
2472	Antenna 1	2518.972	-49.4	-20

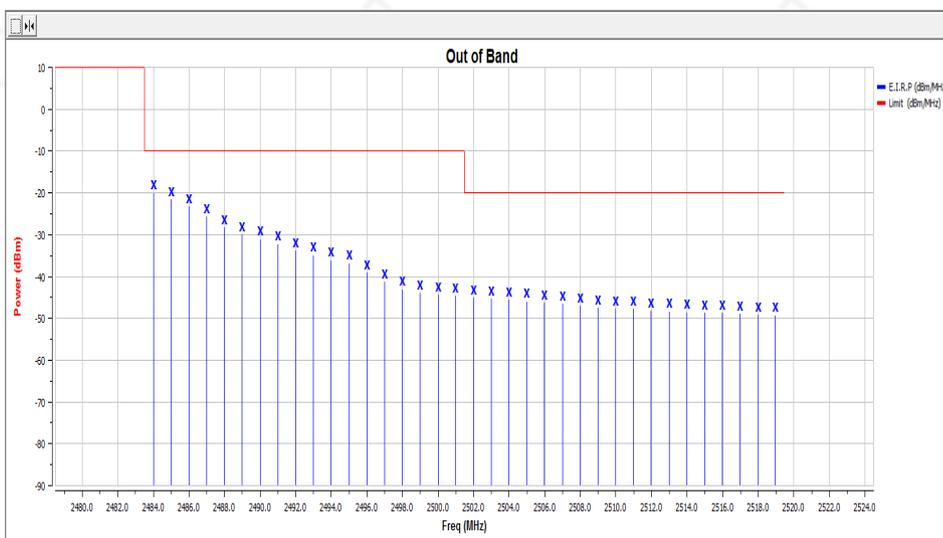

## 8. Receiver Blocking

### 8.1 Limit

Adaptive equipment using wide band modulations other than FHSS, shall comply with the requirements defined in clauses 4.3.2.5.1 (non-LBT based DAA) or 4.3.2.5.2 (LBT based DAA) in the presence of a blocking signal with characteristics as provided in table 6.

**Table 6: Receiver Blocking parameters**

Equipment Type (LBT / non- LBT)	Wanted signal mean power from companion device	Blocking signal frequency [MHz]	Blocking signal power [dBm]	Type of interfering signal
LBT	sufficient to maintain the link (see note 2)	2 395 or 2 488,5 (see note 1)	-30	CW
Non-LBT	-30 dBm			

NOTE 1: The highest blocking frequency shall be used for testing the lowest operating channel, while the lowest blocking frequency shall be used for testing the highest operating channel.  
 NOTE 2: A typical value which can be used in most cases is -50 dBm/MHz.

### 8.2 Test Setup

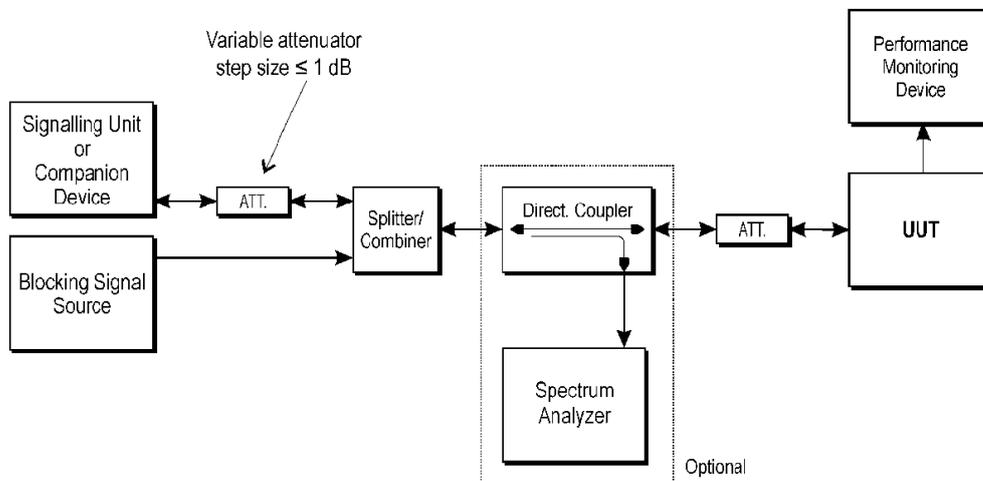

### 8.3 Test Procedure

Refer to ETSI EN 300 328 V2.1.1 (2016-11) Clause 5.3.7.

### 8.4 Test Result

PASS, please refer to clause 5 for details.

Observation Result: Refer to 5 that blocking signal is injected while interference signal is present. With the presence of the blocking signal, channel of the observation does not resume the link.



## 9. Spurious emissions – Transmitter (30- 1000MHz)

### 9.1 Applied procedures / limit

Clause	Test Item	Frequency range	Maximum power, e.r.p. ( $\leq 1$ GHz) e.i.r.p. ( $> 1$ GHz)	RBW/VBW
4.3.2	Spurious emissions (radiated)	30 MHz to 47 MHz	-36 dBm	100 kHz/300KHz
		47 MHz to 74 MHz	-54 dBm	100 kHz/300KHz
		74 MHz to 87,5 MHz	-36 dBm	100 kHz/300KHz
		87,5 MHz to 118 MHz	-54 dBm	100 kHz/300KHz
		118 MHz to 174 MHz	-36 dBm	100 kHz/300KHz
		174 MHz to 230 MHz	-54 dBm	100 kHz/300KHz
		230 MHz to 470 MHz	-36 dBm	100 kHz/300KHz
		470 MHz to 862 MHz	-54 dBm	100 kHz/300KHz
		862 MHz to 1 GHz	-36 dBm	100 kHz/300KHz
		1 GHz to 12,75 GHz	-30 dBm	1 MHz/3MHz

#### 9.1.1 Measuring Instruments and Setting

Please refer to section 7.1.1 in this report. The following table is the setting of the Spectrum Analyzer.

Spectrum Analyzer	Setting
Attenuation	Auto
Start Frequency	30 MHz
Stop Frequency	1000 MHz
Detector	Positive Peak
Span	100 MHz
Sweep Time	1s
RB / VB	100 kHz / 300 kHz

#### 9.1.2 Test Procedures

- The EUT was placed on the top of the turntable in open test site area.
- The test shall be made in the transmitting mode. The turntable was rotated by 360 degrees to determine the position of the highest radiation.
- This measurement shall be repeated with the transmitter in standby mode where applicable.
- For 30~1000MHz spurious emissions measurement, the broad band bi-log receiving antenna was placed 3 meters far away from the turntable.
- The broadband receiving antenna was fixed on the same height with the EUT to find each suspected emissions of both horizontal and vertical polarization. Each recorded suspected value is indicated as Read Level (Raw).
- Replace the EUT by standard antenna and feed the RF port by signal generator.
- Adjust the frequency of the signal generator to the suspected emission and slightly rotate the turntable to locate the position with maximum reading.
- Adjust the power level of the signal generator to reach the same reading with Read Level (Raw).
- The level of the spurious emission is the power level of (8) plus the gain of the standard antenna in dBi and minus the loss of the cable used between the signal generator and the standard antenna.
- If the level calculated in (9) is higher than limit by more than 6dB, then lower the RBW of the spectrum analyzer to 30KHz. If the level of this emission does not change by more than 2dB, then it is taken as narrowband emission, otherwise, wideband emission.
- The measurement shall be repeated at the lowest and the highest channel of the stated frequency range.

### 9.1.3 Test Setup Layout

#### (A) Radiated Emission Test Set-Up, Frequency Below 1000MHz

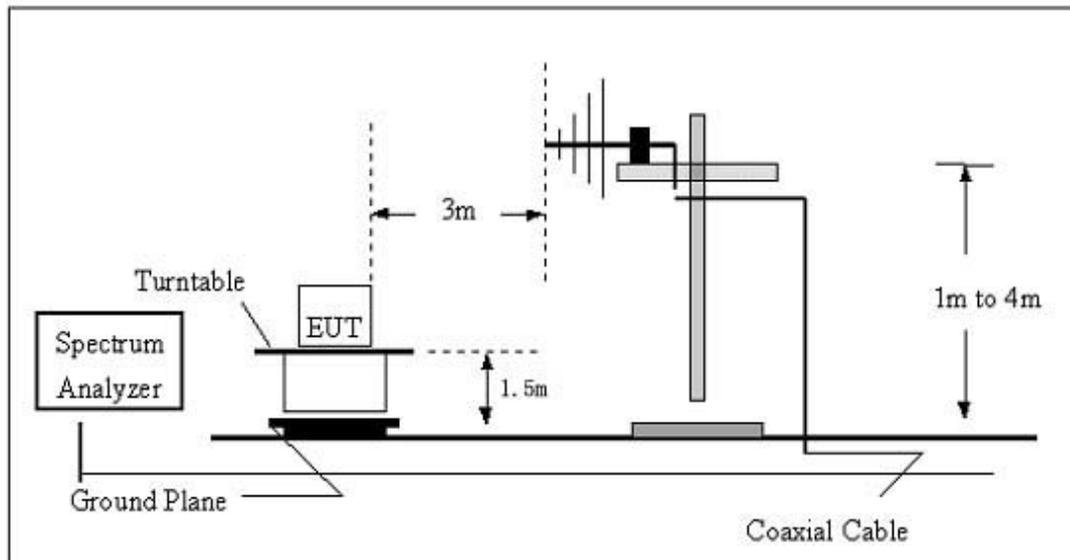

#### 9.1.4 EUT Operation during Test

The EUT was programmed to be in continuously transmitting mode.

#### 9.1.5 Results of Standby Mode Spurious Emissions

For the initial investigation on standby mode and receiving mode, no significant differences in spurious emissions were observed between these 2 modes. So test data for standby mode was omitted in this section.

#### 9.1.6 TEST RESULTS (30MHz ~ 1000MHz)



EUT :	Sonoff WiFi smart switch	Model Name :	Sonoff RF
Temperature :	24 °C	Relative Humidity :	54%
Pressure :	1010 hPa	Test Power :	AC 230V/50HZ

	Frequency (MHz)	Ant H / V	TX/RX	Measure d(FS) (dBm)	Limits (dBm)	Margins	Note
802.11b	50.12	H	TX	-68.91	-54.00	14.91	
	105.32	H	TX	-69.83	-54.00	15.83	
	188.35	H	TX	-69.03	-54.00	15.03	
	475.36	H	TX	-67.86	-54.00	13.86	
	642.32	H	TX	-67.41	-54.00	13.41	
	850.14	H	TX	-66.06	-54.00	12.06	
802.11b	51.36	V	TX	-64.91	-54.00	10.91	
	180.15	V	TX	-68.74	-54.00	14.74	
	225.36	V	TX	-64.93	-54.00	10.93	
	523.17	V	TX	-65.17	-54.00	11.17	
	633.19	V	TX	-66.03	-54.00	12.03	
	820.13	V	TX	-63.71	-54.00	9.71	
802.11g	60.28	H	TX	-66.15	-54.00	12.15	
	105.69	H	TX	-68.11	-54.00	14.11	
	220.39	H	TX	-60.53	-54.00	6.53	
	621.14	H	TX	-60.04	-54.00	6.04	
	731.45	H	TX	-61.44	-54.00	7.44	
	831.17	H	TX	-63.89	-54.00	9.89	
802.11g	70.39	V	TX	-61.44	-54.00	7.44	
	105.97	V	TX	-59.51	-54.00	5.51	
	217.84	V	TX	-62.05	-54.00	8.05	
	621.76	V	TX	-58.93	-54.00	4.93	
	721.34	V	TX	-63.78	-54.00	9.78	
	833.33	V	TX	-63.92	-54.00	9.92	

Remark:

(2) Data of measurement within this frequency range shown “\*” in the table above means the reading of emissions are attenuated more than 20dB below the permissible limits or the field strength is too small to be measured.

(3) The EUT can't be operated in the standby mode and it's always keep continuously transmitting.



EUT :	Sonoff WiFi smart switch	Model Name :	Sonoff RF
Temperature :	24 °C	Relative Humidity :	54%
Pressure :	1010 hPa	Test Power :	AC 230V/50HZ

	Frequency (MHz)	Ant H / V	TX/RX	Measure d(FS) (dBm)	Limits (dBm)	Margins	Note
802.11n 20	56.17	H	TX	-65.89	-54.00	11.89	
	98.17	H	TX	-64.89	-54.00	10.89	
	221.36	H	TX	-68.17	-54.00	14.17	
	490.38	H	TX	-66.81	-54.00	12.81	
	624.25	H	TX	-65.73	-54.00	11.73	
	805.46	H	TX	-65.75	-54.00	11.75	
802.11n 20	68.59	V	TX	-66.45	-54.00	12.45	
	105.29	V	TX	-66.83	-54.00	12.83	
	234.62	V	TX	-67.44	-54.00	13.44	
	573.17	V	TX	-66.01	-54.00	12.01	
	661.39	V	TX	-65.48	-54.00	11.48	
	774.18	V	TX	-66.71	-54.00	12.71	

**Remark:**

(2) Data of measurement within this frequency range shown "\*" in the table above means the reading of emissions are attenuated more than 20dB below the permissible limits or the field strength is too small to be measured.

(3) The EUT can't be operated in the standby mode and it's always keep continuously transmitting.



## 10. Spurious emissions – TRANSMITTER (above 1000MHz)

### 10.1 Applied procedures / limit

Clause	Test Item	Frequency range	Maximum power, e.r.p. ( $\leq 1$ GHz) e.i.r.p. ( $> 1$ GHz)	RBW/VBW
4.3.2	Spurious emissions (radiated)	30 MHz to 47 MHz	-36 dBm	100 kHz/300KHz
		47 MHz to 74 MHz	-54 dBm	100 kHz/300KHz
		74 MHz to 87,5 MHz	-36 dBm	100 kHz/300KHz
		87,5 MHz to 118 MHz	-54 dBm	100 kHz/300KHz
		118 MHz to 174 MHz	-36 dBm	100 kHz/300KHz
		174 MHz to 230 MHz	-54 dBm	100 kHz/300KHz
		230 MHz to 470 MHz	-36 dBm	100 kHz/300KHz
		470 MHz to 862 MHz	-54 dBm	100 kHz/300KHz
		862 MHz to 1 GHz	-36 dBm	100 kHz/300KHz
		1 GHz to 12,75 GHz	-30 dBm	1 MHz/3MHz

#### 10.1.1 Measuring Instruments and Setting

Please refer to section 7.1.1 in this report. The following table is the setting of the Spectrum Analyzer.

Spectrum Analyzer	Setting
Attenuation	Auto
Start Frequency	1000 MHz
Stop Frequency	12750 MHz
Detector	Positive Peak
Span	100 MHz
Sweep Time	1s
RB / VB	1MHz / 3MHz

#### 10.1.2 Test Procedures

- The EUT was placed on the top of the turntable in open test site area.
- The test shall be made in the transmitting mode. The turntable was rotated by 360 degrees to determine the position of the highest radiation.
- This measurement shall be repeated with the transmitter in standby mode where applicable.
- For 30~1000MHz spurious emissions measurement, the broad band bi-log receiving antenna was placed 3 meters far away from the turntable.
- The broadband receiving antenna was fixed on the same height with the EUT to find each suspected emissions of both horizontal and vertical polarization. Each recorded suspected value is indicated as Read Level (Raw).
- Replace the EUT by standard antenna and feed the RF port by signal generator.
- Adjust the frequency of the signal generator to the suspected emission and slightly rotate the turntable to locate the position with maximum reading.
- Adjust the power level of the signal generator to reach the same reading with Read Level (Raw).

- i. The level of the spurious emission is the power level of (8) plus the gain of the standard antenna in dBi and minus the loss of the cable used between the signal generator and the standard antenna.
- j. If the level calculated in (9) is higher than limit by more than 6dB, then lower the RBW of the spectrum analyzer to 30KHz. If the level of this emission does not change by more than 2dB, then it is taken as narrowband emission, otherwise, wideband emission.
- k. The measurement shall be repeated at the lowest and the highest channel of the stated frequency range.

### 10.1.3 Test Setup Layout

#### (B) Radiated Emission Test Set-Up Frequency Above 1 GHz

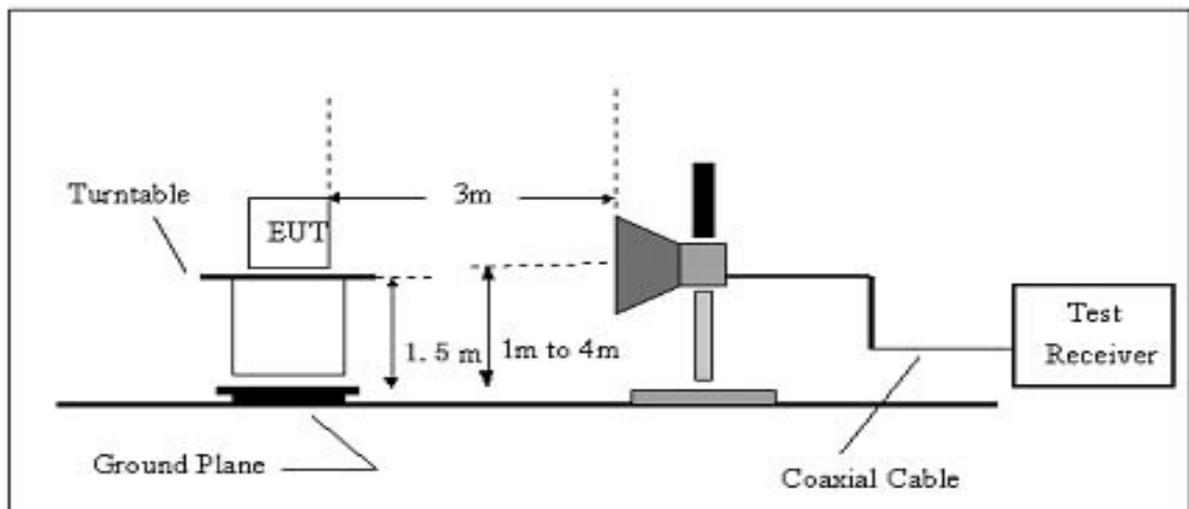

#### 10.1.4 EUT Operation during Test

The EUT was programmed to be in continuously transmitting mode.

#### 10.1.5 Results of Standby Mode Spurious Emissions

For the initial investigation on standby mode and receiving mode, no significant differences in spurious emissions were observed between these 2 modes. So test data for standby mode was omitted in this section.



## 10.1.6 TEST RESULTS

EUT :	Sonoff WiFi smart switch	Model Name :	Sonoff RF
Temperature :	24 °C	Relative Humidity:	54%
Pressure :	1010 hPa	Test Power :	AC 230V/50HZ (11b)

	Frequency (MHz)	Ant H / V	TX/RX	Measure d(FS) (dBm)	Limits (dBm)	Margins	Note
11B 2412MHz	4824.000	V	TX	-46.75	-30.00	16.75	
	7236.000	V	TX	-44.35	-30.00	14.35	

11B 2412MHz	4824.000	H	TX	-46.19	-30.00	16.19	
	7236.000	H	TX	-41.73	-30.00	11.73	

11B 2442MHz	4884.000	V	TX	-42.05	-30.00	12.05	
	7326.000	V	TX	-40.21	-30.00	10.21	

11B 2442MHz	4884.000	H	TX	-47.06	-30.00	17.06	
	7326.000	H	TX	-42.08	-30.00	12.08	

11B 2472MHz	4944.000	V	TX	-44.50	-30.00	14.50	
	7416.500	V	TX	-42.19	-30.00	12.19	

11B 2472MHz	4944.000	H	TX	-45.03	-30.00	15.03	
	7416.500	H	TX	-44.44	-30.00	14.44	

## Note:

- (1) Data of measurement within this frequency range shown "\*" in the table above means the reading of emissions are attenuated more than 20dB below the permissible limits or the field strength is too small to be measured.
- (2) The EUT can't be operated in the standby mode and it's always keep continuously receiving.
- (3) Measuring frequency from 1GHz to 12.75GHz.



EUT :	Sonoff WiFi smart switch	Model Name :	Sonoff RF
Temperature :	24 °C	Relative Humidity	54%
Pressure :	1010 hPa	Test Power :	AC 230V/50HZ (11g)

	Frequency	Ant	TX/RX	Measure d(FS)	Limits	Margins	Note
	(MHz)	H / V		(dBm)	(dBm)		
11G 2412MHz	4824.000	V	TX	-46.22	-30.00	16.22	
	7236.000	V	TX	-44.01	-30.00	14.01	

11G 2412MHz	4824.000	H	TX	-44.85	-30.00	14.85	
	7236.000	H	TX	-40.96	-30.00	10.96	

11G 2442MHz	4884.000	V	TX	-44.10	-30.00	14.10	
	7326.000	V	TX	-40.93	-30.00	10.93	

11G 2442MHz	4884.000	H	TX	-44.44	-30.00	14.44	
	7326.000	H	TX	-42.53	-30.00	12.53	

11G 2472MHz	4944.000	V	TX	-46.39	-30.00	16.39	
	7416.500	V	TX	-43.20	-30.00	13.20	

11G 2472MHz	4944.000	H	TX	-44.00	-30.00	14.00	
	7416.500	H	TX	-41.02	-30.00	11.02	

Note:

- (1) Data of measurement within this frequency range shown “\* ” in the table above means the reading of emissions are attenuated more than 20dB below the permissible limits or the field strength is too small to be measured.
- (2) The EUT can't be operated in the standby mode and it's always keep continuously receiving.
- (3) Measuring frequency from 1GHz to 12.75GHz.



EUT :	Sonoff WiFi smart switch	Model Name :	Sonoff RF
Temperature :	24 °C	Relative Humidity	54%
Pressure :	1010 hPa	Test Power :	AC 230V/50HZ (11 N20)

	Frequency	Ant	TX/RX	Measure d(FS)	Limits	Margins	Note
	(MHz)	H / V		(dBm)	(dBm)		
11 N20 2412MHz	4824.000	V	TX	-45.20	-30.00	15.20	
	7236.000	V	TX	-43.11	-30.00	13.11	

11 N20 2412MHz	4824.000	H	TX	-45.05	-30.00	15.05	
	7236.000	H	TX	-41.04	-30.00	11.04	

11 N20 2442MHz	4884.000	V	TX	-47.85	-30.00	17.85	
	7326.000	V	TX	-43.58	-30.00	13.58	

11 N20 2442MHz	4884.000	H	TX	-46.97	-30.00	16.97	
	7326.000	H	TX	-44.80	-30.00	14.80	

11 N20 2472MHz	4944.000	V	TX	-44.28	-30.00	14.28	
	7416.500	V	TX	-42.44	-30.00	12.44	

11 N20 2472MHz	4944.000	H	TX	-45.35	-30.00	15.35	
	7416.500	H	TX	-41.30	-30.00	11.30	

Note:

- (1) Data of measurement within this frequency range shown “\* ” in the table above means the reading of emissions are attenuated more than 20dB below the permissible limits or the field strength is too small to be measured.
- (2) The EUT can't be operated in the standby mode and it's always keep continuously receiving.
- (3) Measuring frequency from 1GHz to 12.75GHz.



## 11. Spurious emissions – RECEIVER (30-1000MHz)

### 11.1 Applied procedures / limit

Clause	Test Item	Frequency(MHz)	Limit
4.3.5	Spurious emissions	30-1000	-57dBm
	(radiated)	1000-12750	-47dBm

#### 11.1.1 Measuring Instruments and Setting

Please refer to section 8.1.1 in this report. The following table is the setting of the Spectrum Analyzer.

Spectrum Analyzer	Setting
Attenuation	Auto
Start Frequency	30 MHz
Stop Frequency	1000 MHz
Detector	Positive Peak
Span	100 MHz
Sweep Time	1s
RB / VB	100 kHz / 300 kHz

#### 11.1.2 Test Procedures

- The EUT was placed on the top of the turntable in open test site area.
- The test shall be made in the receiving mode. The turntable was rotated by 360 degrees to determine the position of the highest radiation.
- For 30~1000MHz spurious emissions measurement, the broad band bi-log receiving antenna was placed 3 meters far away from the turntable. .
- The broadband receiving antenna was fixed on the same height with the EUT to find each suspected emissions of both horizontal and vertical polarization. Each recorded suspected value is indicated as Read Level (Raw).
- Replace the EUT by standard antenna and feed the RF port by signal generator.
- Adjust the frequency of the signal generator to the suspected emission and slightly rotate the turntable to locate the position with maximum reading.
- Adjust the power level of the signal generator to reach the same reading with Read Level (Raw).
- The level of the spurious emission is the power level of (7) plus the gain of the standard antenna in dBi and minus the loss of the cable used between the signal generator and the standard antenna.
- The measurement shall be repeated at the lowest and the highest channel of the stated frequency range.

#### 11.1.3 Test Setup Layout

This test setup layout is the same as that shown in section 6.1.4

#### 11.1.4 EUT Operation during Test

The EUT was programmed to be in continuously receiving mode.



## 11.1.5 TEST RESULTS (30MHz-1000MHz)

EUT :	Sonoff WiFi smart switch	Model Name :	Sonoff RF
Temperature :	24 °C	Relative Humidity :	54%
Pressure :	1010 hPa	Test Power :	AC 230V/50HZ V

	Frequency (MHz)	Ant H / V	TX/RX	Measure d(FS) (dBm)	Limits (dBm)	Margins	Note
RX Mode	66.2100	V	RX	-61.92	-57.00	4.92	
	131.4600	V	RX	-62.74	-57.00	5.74	
	145.7200	V	RX	-61.98	-57.00	4.98	
	1219.5600	V	RX	-62.77	-57.00	5.77	
	455.5200	V	RX	-61.77	-57.00	4.77	
	619.0200	V	RX	-61.77	-57.00	4.77	
RX Mode	85.1100	H	RX	-61.03	-57.00	4.03	
	120.9600	H	RX	-59.93	-57.00	2.93	
	278.6900	H	RX	-60.05	-57.00	3.05	
	388.4900	H	RX	-60.86	-57.00	3.86	
	495.2100	H	RX	-59.92	-57.00	2.92	
	789.4300	H	RX	-58.70	-57.00	1.70	

## Note:

- (1) Data of measurement within this frequency range shown "\*" in the table above means the reading of emissions are attenuated more than 20dB below the permissible limits or the field strength is too small to be measured.
- (2) The EUT can't be operated in the standby mode and it's always keep continuously receiving.



## 12. Spurious emissions – RECEIVER (above 1000MHz)

### 12.1 Applied procedures / limit

Clause	Test Item	Frequency(MHz)	Limit
4.3.5	Spurious emissions	30-1000	-57dBm
	(narrowband)	1000-12750	-47dBm

#### 12.1.1 Measuring Instruments and Setting

Please refer to section 9.1.1 in this report. The following table is the setting of the Spectrum Analyzer.

Spectrum Analyzer	Setting
Attenuation	Auto
Start Frequency	1000 MHz
Stop Frequency	12750 MHz
Detector	Positive Peak
Span	100 MHz
Sweep Time	1s
RB / VB	1MHz / 3MHz

#### 12.1.2 Test Procedures

- The EUT was placed on the top of the turntable in open test site area.
- The test shall be made in the receiving mode. The turntable was rotated by 360 degrees to determine the position of the highest radiation.
- For 30~1000MHz spurious emissions measurement, the broad band bi-log receiving antenna was placed 3 meters far away from the turntable. .
- The broadband receiving antenna was fixed on the same height with the EUT to find each suspected emissions of both horizontal and vertical polarization. Each recorded suspected value is indicated as Read Level (Raw).
- Replace the EUT by standard antenna and feed the RF port by signal generator.
- Adjust the frequency of the signal generator to the suspected emission and slightly rotate the turntable to locate the position with maximum reading.
- Adjust the power level of the signal generator to reach the same reading with Read Level (Raw).
- The level of the spurious emission is the power level of (7) plus the gain of the standard antenna in dBi and minus the loss of the cable used between the signal generator and the standard antenna.
- The measurement shall be repeated at the lowest and the highest channel of the stated frequency range.

#### 12.1.3 Test Setup Layout

This test setup layout is the same as that shown in section 7.1.3

#### 12.1.4 EUT Operation during Test

The EUT was programmed to be in continuously receiving mode.



## 12.1.5 TEST RESULTS (Above 1000MHz)

EUT :	Sonoff WiFi smart switch	Model Name :	Sonoff RF
Temperature :	24 °C	Relative Humidity :	54%
Pressure :	1010 hPa	Test Power :	AC 230V/50HZ

	Frequency (MHz)	EUT Axis (X/Y/Z)	TX/RX	Measure d(FS) (dBm)	Limits (dBm)	Margins	Note
RX Mode	1679.300	X	RX	-63.23	-47.00	16.23	
	3587.500	X	RX	-62.18	-47.00	15.18	

	Frequency (MHz)	EUT Axis (X/Y/Z)	TX/RX	Measure d(FS) (dBm)	Limits (dBm)	Margins	Note
RX Mode	1679.300	X	RX	-64.07	-47.00	17.07	
	3587.500	X	RX	-61.50	-47.00	14.50	

## Note:

- (1) Data of measurement within this frequency range shown “\* ” in the table above means the reading of emissions are attenuated more than 20dB below the permissible limits or the field strength is too small to be measured.
- (2) The EUT can't be operated in the standby mode and it's always keep continuously receiving.
- (3) Measuring frequency from 1GHz to 12.75GHz.



### 13. TEST PHOTOGRAPH

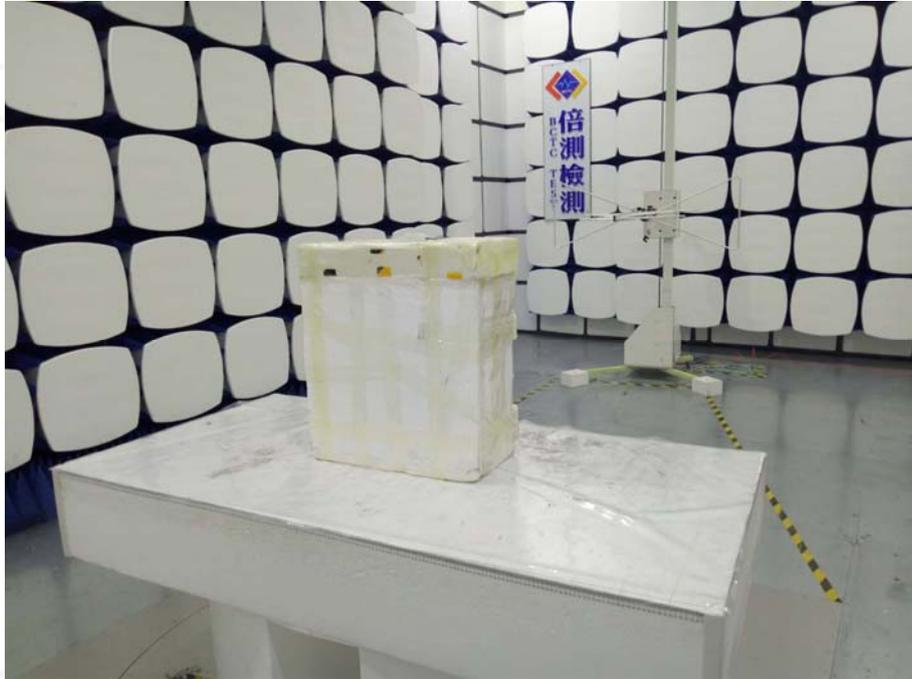

## 14. PHOTOS OF THE EUT

EUT Photo 1



EUT Photo 2

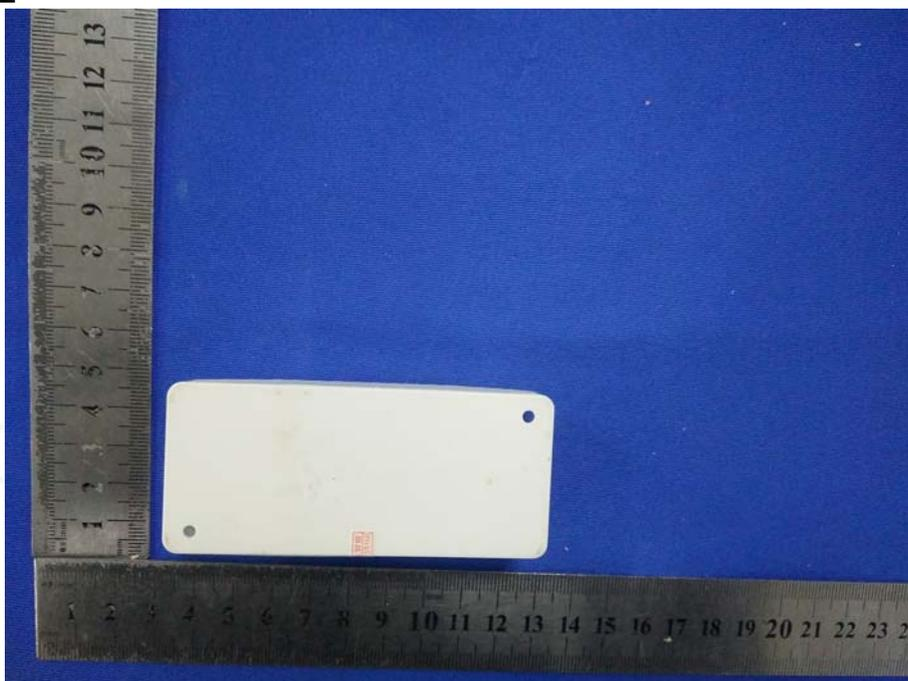

**EUT Photo 3**

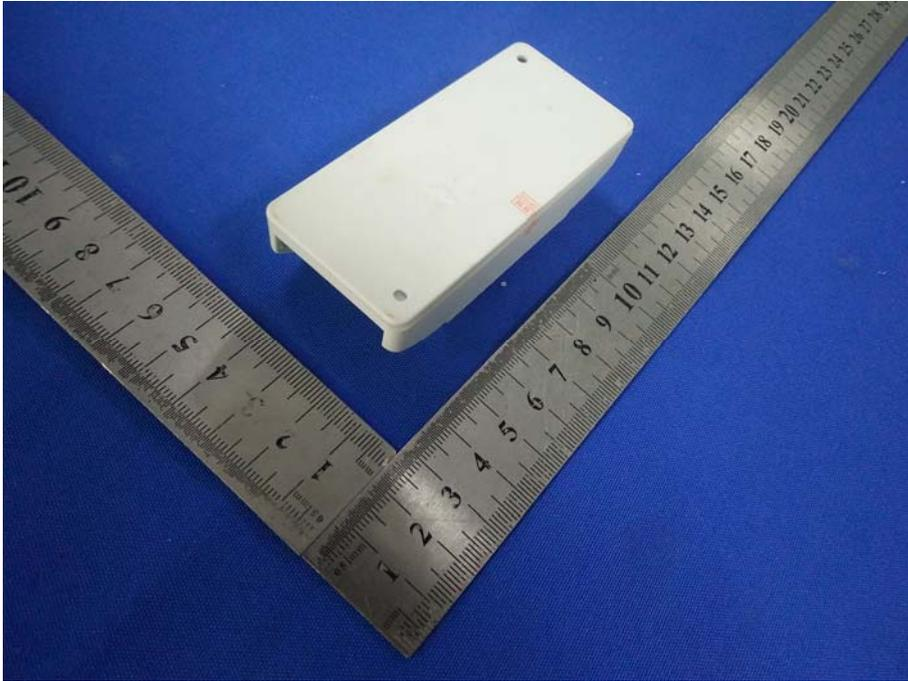

**EUT Photo 4**

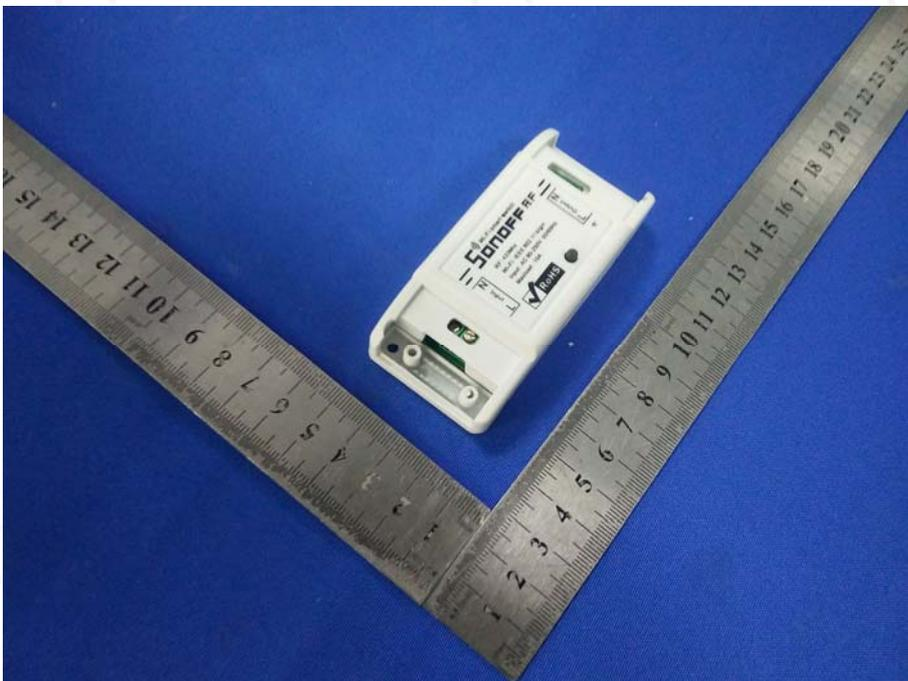

EUT Photo 5



EUT Photo 6



EUT Photo 7

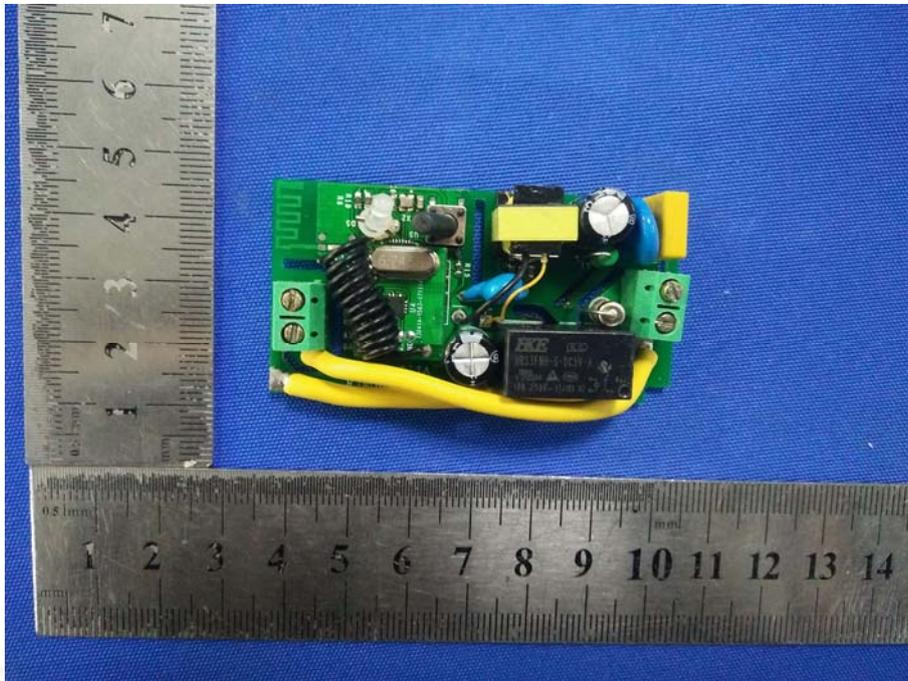

EUT Photo 8

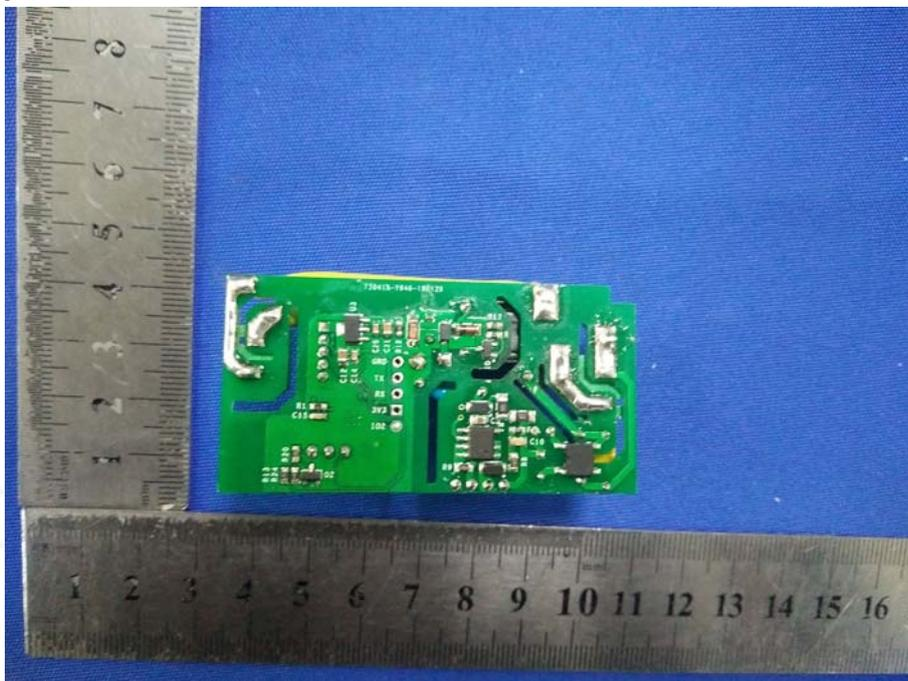

\*\*\*\*\* END OF REPORT \*\*\*\*\*